

***Tiger***

**TWH-01**

**Electronic Physician Scale with BMI**

**Operation Manual**

Contents subject to change without notice

Version 1.0  
2019-4-22

# CONTENTS

<b>1. INTRODUCTION .....</b>	<b>1</b>
General Information .....	1
Specifications .....	1
<b>2. Unpacking and Setup .....</b>	<b>2</b>
<b>3. OVERVIEW OF CONTROLS AND FUNCTIONS .....</b>	<b>4</b>
3.1 Display Descriptions .....	4
3.2 Key Description .....	5
3.3 Indicator Display Character Definitions .....	6
<b>4. OPERATIONS .....</b>	<b>7</b>
4.1 Correct Weighing .....	7
4.2 How to change the unit .....	7
4.3 Tare function .....	7
4.4 Weighing with preset tare values .....	8
4.5 HOLD function .....	8
4.6 BMI function .....	8
4.7 Connecting additional devices .....	9
4.8 Print out a record .....	9
<b>5. Troubleshooting .....</b>	<b>10</b>

# 1. INTRODUCTION

## General Information

Thank you for purchasing the scale. Please read all operating instructions carefully before use and keep the following points in mind:

- Avoid lengthy exposure to extreme heat or cold, your scale works best when operated at normal room temperature. Always allow the scale to acclimate to a normal room temperature before use
- Allow sufficient warm up time. Turn the scale on and wait for a few minutes if possible, to give the internal components a chance to stabilize before weighing.
- These electronic scales are precision instruments. Do not operate near an in-use cell phone, radio, computer or other electronic device. These devices emit RF and can cause unstable scale readings. If your scale ever performs poorly, try moving the scale to a different room or location.
- Avoid using in condition of heavy vibration and airflow.
- Read the weight reading in short time after loading. The output signature of load cell and A/D may be little influenced after weighing for a long time.

## Specifications

<b>Model</b>	<b>TWH-01</b>
<b>Maximum capacity</b>	300kg /600 lb
<b>Minimum weight</b>	2 kg / 4 lb
<b>Scale division</b>	0.1 kg / 0.2 lb
<b>Weighing units</b>	Kg, lb
<b>Display</b>	6 digits 1" (25mm) high, 7 segments LCD display with backlight
<b>Height rod range</b>	60-212cm / 23"-83"
<b>Interface</b>	RS232, USB
<b>Platform size</b>	275mm x 375mm 10.83" x 14.76"
<b>Overall dimension</b>	291mm x 617mm x 1309mm 11.46" x 24.29" x 51.54"
<b>Environment for Use</b>	Temperature: 5°C-40°C; Humidity: <85% RH
<b>Power</b>	Batteries: 4 x "AA" size cells (not included) AC Adapter: 9Vdc/600mA, with central positive (included) 

## 2. UNPACKING AND INSTALLATION

Take all scale parts out of the carton and put them on a flat and hard surface. Follow below procedures to fulfill the installation.

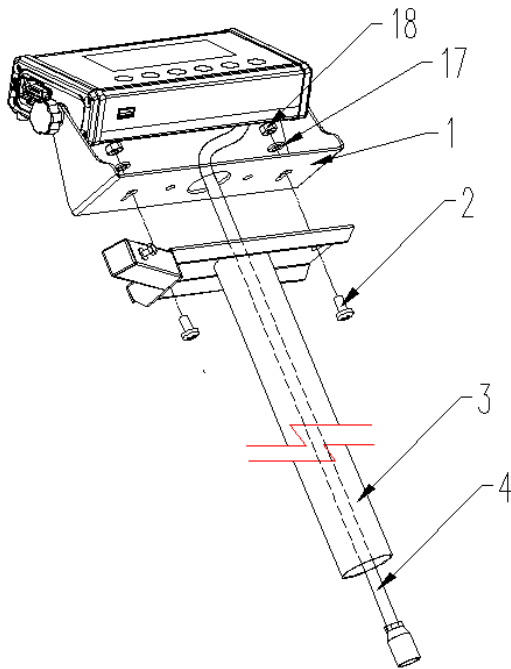

1. Place the cable (4) through the pillar (3).
2. Insert the pillar (3) into the tube support (6).
3. Put the indicator bracket on the pillar bracket.
4. Insert the 2 screws (2) through the holes on the pillar bracket, tighten with nuts (18) and flat washers (17), secure the bracket of pillar to the indicator bracket (1),
5. Make sure the screws are securely tightened.

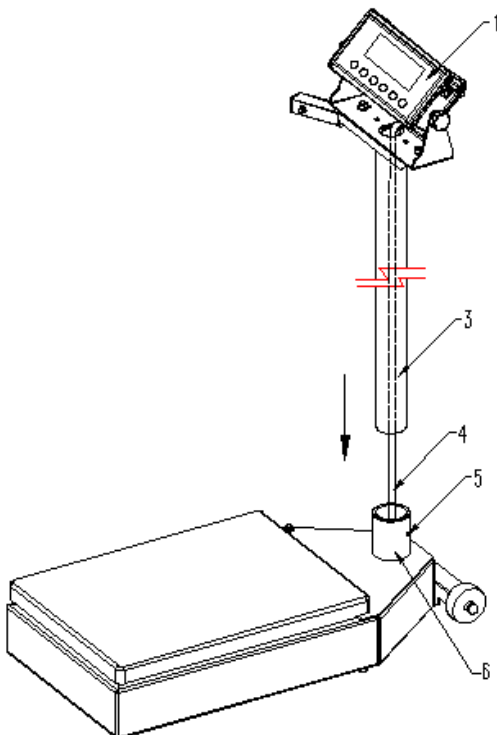

6. Plug the connectors of indicator cable and load cell cable from base together.
7. Rotate the pillar to position the indicator (1) in the direction desired, and then tighten the 2 screws (5) into the fixing tube (6).

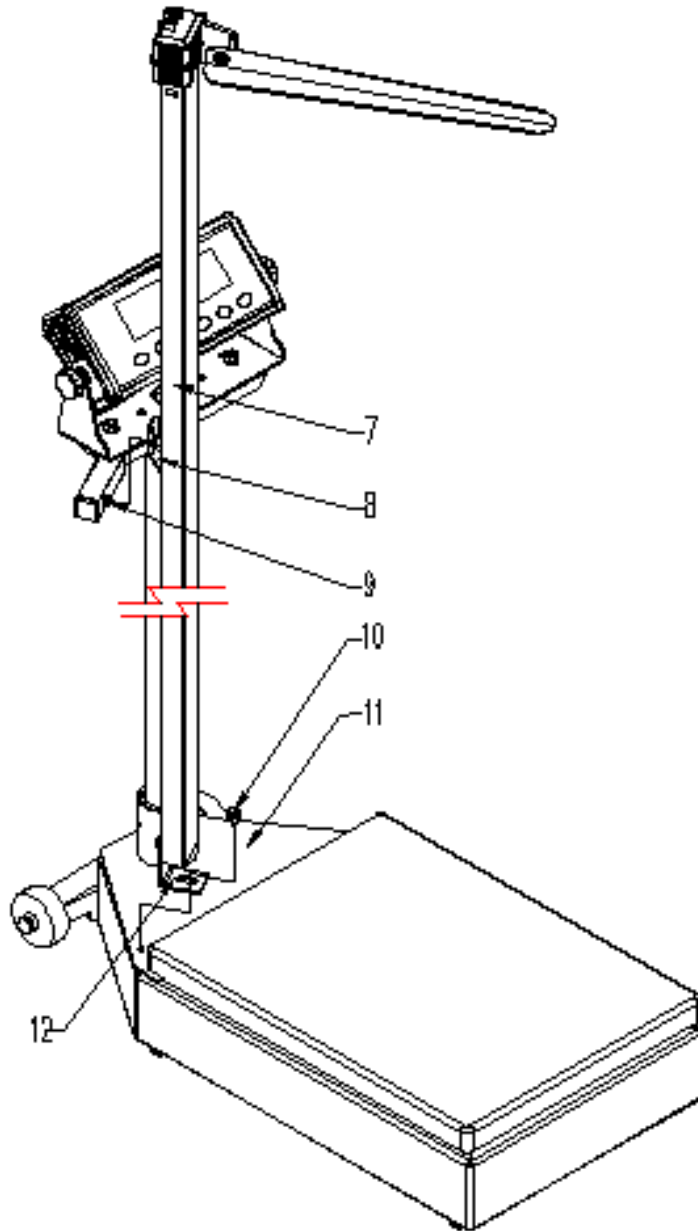

8. Loosen the screw on the upper bracket (8).
9. Locate the height rod (7) onto the fixing points (9) of the upper bracket (8) & lower bracket (12).
10. Secure the bolt and washer to the bracket on the base (10).
11. Tighten the bolt on the upper bracket (9).

### 3. OVERVIEW OF CONTROLS AND FUNCTIONS

#### 3.1 Display Descriptions

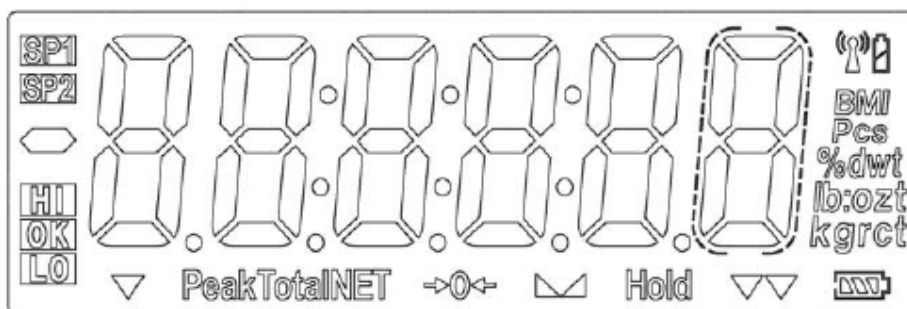





































Name	Description
	Status indicator for the current battery charge level. When this symbol appears is the scale in battery operation mode or will be charged.
→0←	The scale is within the zero level.
	The scale is at a standstill, meaning the weight is stable and no movement is on the platform. This is a mandatory precondition for functions such as resetting, printing and taring). In case the LCD is not displayed is the scale not in the standstill mode.
"Hold"	Displayed when the hold function is activated
"lb"	Displayed when the weighing unit is displayed in pounds
"kg"	Displayed when the weight is displayed in kilograms

### 3.2 Key Description



Name	Description
<b>HOLD</b>	Activates the Hold-Function.
<b>PRINT</b>	Output data to serial communication port RS 232.
<b>BMI</b>	Enter, after the user steps on the scale, in order to proceed with the BMI mode.
<b>UNIT</b>	Switch button between primary kgs and secondary units Lbs.
<b><u>TARE</u> PRESET</b>	Activates the tare function and the Preset Tare Function.
<b><u>ZERO</u> ON/OFF</b>	Switch the scale on/off and zero function.
←	During key operation use this key to switch between the units.
→	During key operation use this key to switch between the units.
↓	During key operation use this key to switch between the numbers downwards.
↑	During key operation use this key to switch between the numbers upwards.
↵	Enter button to confirm the value.

### 3.3 Indicator Display Character Definitions

ASCII	LCD/LED Show	ASCII	LCD/LED Show	ASCII	LCD/LED Show
0		A		N	
1		B		O	
2		C		P	
3		D		Q	
4		E		R	
5		F		S	
6		G		T	
7		H		U	
8		I		V	
9		J		W	
		K		X	
		L		Y	
		M		Z	



## **4. OPERATIONS**

### **4.1 Correct Weighing**

- Press the start key **ON/OFF/ZERO** to enter the normal operating mode of the scale with no load on the platform. An automatic function test will be performed as well as the zero setting of the scale. When `0.0` appears, it means you are in the weighing mode. Additionally the display shows the symbol `→0←` to confirm stability of the zero setting.
- The scale is now ready to be used.
- Place the patient on the scale and ensure that he is not moving.
- After the weight is being displayed and the symbol `  ` appears the utmost accuracy has been achieved.
- To turn off the scale press **ON/OFF/ZERO** for a period of minimum 3 seconds.

### **4.2 How to change the unit**

- The scale offers the possibility to select between the weighing mode kg and lb.
- To change into another mode, press the **UNIT** key. Please check weighing mode after switching on to get proper result.

### **4.3 Tare function**

The tare function allows ignoring a fixed weight (e.g. wheelchair) that will be deducted after each weighing procedure.

Proceed as follows:

- Press the **ON/OFF/ZERO** with no load on the scale.
- Place the additional weight of the object(s), which needs to be ignored, on the scale and store the result by pressing the **TARE/PRESET** key.
- The display is being reset to zero. The scale is now in NET weighing mode which is also indicated on the display.
- Remove the objects from the platform. The ignored weight is being displayed with a minus.
- Place the Patient and the additional weight (e.g. in the wheelchair) on the scale.
- The scale determines the weight of the patient without the additional weight. You may now use the scale for as many weighing procedures and the stored value will always be deducted as long as the scale is not turned off.
- When there is no any weight on the platform, enter the **TARE/PRESET** button again to get of the tare mode.
- The tare value is likewise erased by the scale until pressing the **TARE/PRESET** button

when no weight on the platform or being switched off.

#### **4.4 Weighing with preset tare values**

- Press the **ON/OFF/ZERO** with no load on the scale.
- Press and hold the **TARE/PRESET** key until the NET indicator flashes and “Pr.Tare” shows in the display.
- Input the tare weight using the arrow keys (already known the weight of the wheelchair).
- After inputting the tare weight, press the **TARE/PRESET** key to confirm. The NET indicator will be lit on the display.

**Note:** Tare weight must be greater than zero and less than the scale’s maximum capacity.

- Put the patient and the additional weight (e.g. in the wheelchair) to be weighed onto the scale platform. The net weight will be displayed.
- To exit preset tare mode, remove all weight from the scale. The display will show a negative weight. Press the **TARE/PRESET** key to return the display to zero, eliminating the weight of the container.

**Note:** The indicator can only save one tare weight. Entering a new tare weight will automatically replace the old one.

#### **4.5 HOLD function**

The Hold function is being used if you like to hold the results at the display after the weight/load has been removed from the scale. Use this button to take care of the patient first and then note the weight.

- Press **HOLD/SETUP** key while scale is under load.
- “**HOLD**” is being displayed at the screen.
- The weight remains saved in the display after unloading the scale.
- For deactivation of the Hold function press again the **HOLD/SETUP** key.

#### **4.6 BMI function**

The Body Mass Index is the ratio between height and weight squared. The BMI is accepted world wide – also by WHO (World Health Organization) - helping to evaluate the state of nutrition and with that value also the state of health of a person. The result is a tolerance value.

- Start the scale by entering the **ON/OFF/ZERO** Button. The scale is automatically being set to zero.
- Step on the scale or helping the patient to get into the wheelchair and on the platform.
- Wait until the weight is being displayed in a stable condition and ‘  ’ appears on the screen.

- Press the **BMI** key shortly.
- The scale starts automatically with the last input. Use the  $\uparrow \downarrow \leftarrow \rightarrow$ ns to enter the height of the patient, and confir  $\leftarrow$  he height with the enter button
- The BMI is now being displayed at the indicator.
- To correct the given height press the **BMI** button once again and the display returns to the height mode.
- To get back into normal weighing mode and leave the BMI modus, press the **TARE** button.

### Evaluation of the Body Mass

Index Compare the determined value which corresponds to those being used by the WHO.

#### **BMI below 18,5**

- The patient is under the regular standard and does not got enough weight. An increase of weight is recommended. Please consult a professional.

#### **BMI between 18,5 and 24,9**

- The patient got a normal weight. If he feels well there is no need for a change.

#### **BMI between 25 and 30**

- The patient is slightly overweighed to pre-obese. A reduction of weight is indicated or, is necessary if the state of health is already affected (e.g. diabetes, high end blood pressure, heart diseases).

#### **BMI over 30**

- Reduction of weight is imperative. To visit a doctor is highly recommended.

## 4.7 Connecting additional devices

Connection of printer, PC or remote-display will be done with serial ports. For connection of additional devices kindly ask the manufacturer for further instructions.

## 4.8 Record print out

The scales must be at standstill. The standstill status symbol  must appear on the screen.

Press the **PRINT** key to send the data to the serial interface.

**Note:** Printing is not possible if the net weight is 0. The print function only produces one print-out. A repeated weighing process is required to print out another copy.

## 5. TROUBLESHOOTING

Display	Probable causes	Remedy
Ad-----	Load cell wires to indicator are incorrectly connected, or shorted, or opened; or ADC, load cell are damaged	Make sure wires are ok and correctly connected. Replace load cell or ADC chip, Service required.
Ad-----		
0-----	Weight reading exceeds Power On Zero limit.	Make sure scale platform is empty. Perform zero calibration.
0-----	Weight reading below Power On Zero limit.	Install platform on scale. Perform zero calibration.
-----	Weight reading exceeds overload limit, or The weight value cannot be displayed in the current unit of measure because it exceeds 6 digits.	Reduce load on scale until weight value can be displayed. Use a more appropriate unit of measure. Contact your local dealer or supplier for a new set up.
-----	Weight reading below Under load limit.	Install platform on scale. Perform zero calibration
EEP.E1	CONFIG or CAL parameters are not correctly set	Contact your local dealer or supplier for a new set up
EEP.E2	USER parameter is not correctly set	Contact your local dealer or supplier for a new set up
CAP.ER	Capacity parameters are not correct	Contact your local dealer or supplier for a new set up
CAL.Er	Calibration error, maybe input data or loaded weight is too small, too big, unstable, un-linear	Input correct data, load correct weight onto platform, Service required
<b>Not turn on.</b>	Power cord not plugged in or properly connected. Power outlet not supplying electricity. Battery discharged.	Check power cord connections. Make sure power cord is plugged into the power outlet. Check power source. Replace batteries.
	Other failure.	Service required.
<b>Scale can't set to zero or will not zero when turned on</b>	Load on scale exceeds allowable limits. Load on scale is not stable. Load cell damage.	Remove load on scale. Wait for load to become stable.  Service required.
<b>Empty battery symbol/ Lo.bAt is shown</b>	Batteries are discharged.	Charge batteries