

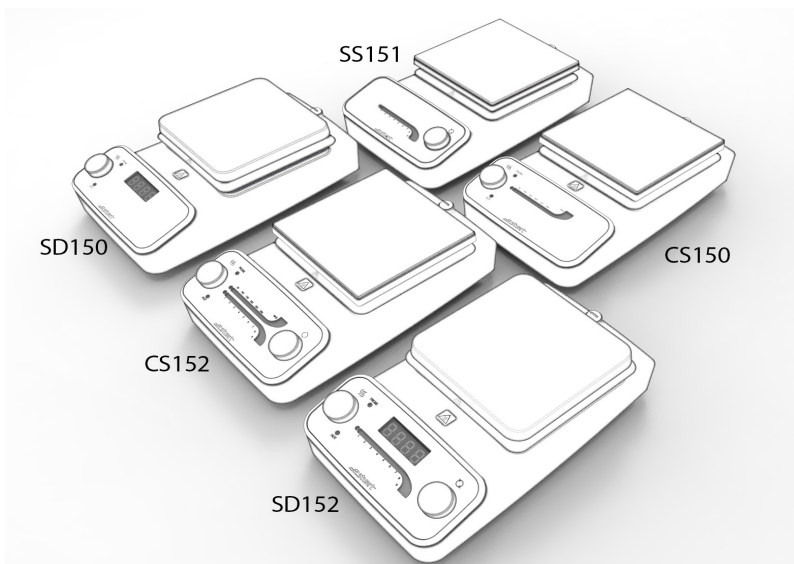

Instruction Manual

For all Hotplates and Stirrers



HS100-060 Version 1.2

DIGITAL INTERFACE PRODUCTS

SD150x, SD150x/120, CD150x, CD150x/120, SD152x, SD152x/120, CD152x, CD152x/120

x is used for the letter denoting colour variant (blue (B), black (K) or white (W))

STANDARD ANALOGUE INTERFACE PRODUCTS

SS150x, SS150x/120, CS150x, CS150x/120, SS151x, CS151, SS152x, SS152x/120, CS152x, CS152x/120

x is used for the letter denoting colour variant (blue (B), black (K) or white (W))

About This Manual

This manual is designed to assist you in optimal usage of your new digital or analogue hotplate. To get the best performance from your equipment and for your own personal safety, please read these instructions carefully before use

Before discarding the packaging check that all parts are present and correct

Product Voltages

All Hotplate stirrers and hotplates are available in different voltages (230/120VAC), however, the analogue stirrer is 100-240 VAC compliant

Before initial use, check that the unit you received is the correct voltage for your location



Table of Contents

- About This Manual 1
- Safety Information 2
- Operating Conditions..... 3
- Unpacking & Contents..... 4
- Electrical Installation 5
- Product Connections 6
- Connect To The External Controller 6
- Ceramic Hotplate Hot Zone 7
- Analogue Stirrer..... 7
- Analogue Hotplate..... 9
- Analogue Hotplate Stirrer..... 11
- Digital Hotplate..... 13
- Digital Hotplate Stirrer..... 14
- External Controller (SCT1)..... 17
- Troubleshooting..... 17
- Product Repair 18
- Product Maintenance..... 18
- Optional Accessories 19
- Replacement Parts 19
- Technical Specifications..... 20
- CE Declaration of Conformity 20
- Product Disposal 21
- Warranty Statement..... 21
- Your Purchase Record 22
- Customer Support 22









Safety Information

This instruction manual contains important operating and maintenance instructions which must be read, understood and followed by the product user. Failure to use this instruction manual may degrade or defeat the protection normally provided by the product. Read this instruction manual prior to product use and keep this information for future reference

Product Symbols

Throughout this instruction manual the following symbols are shown to identify conditions which pose a hazard to the user, or to identify actions that should be observed. These symbols are also shown on the product or its packaging

	Warning symbol		stir symbol
	Caution hot surface		Hotplate symbol
	Recyclable packing material		Provide lasting protection against microbes, such as bacteria, mould and viruses
	Do not dispose of product in normal domestic waste		

Warnings

Personal Injury



- Do not use this product in a manner other than stated in the operating conditions section of the manual as protection provided to the equipment may be impaired
- This equipment is designed for use in laboratory environments by persons knowledgeable in safe laboratory practices
- Do not touch the hotplate or any glass vessel whilst in use

Electric Shock



- This product must be connected to a grounded power outlet for safe functioning
- Use the power cord supplied with the unit
- Do not open the product case - only qualified service personnel should attempt to repair this product

- Position the product for use so that the power cord can be easily disconnected without having to move the product
- Disconnect the power cord before moving or cleaning the unit
- Ensure the mains power supply conforms to the rating found on the rating label on the underside of the unit
- Never operate the equipment without a connection to earth. Ensure the mains supply voltage is correctly earthed/grounded with current area legislation



Product Damage

- Keep the product dry and clean
- Do not immerse the product for cleaning
- Do not heat or stir volatile or flammable materials
- These units are not explosion or spark proof
- Do not use the product near volatile or flammable materials
- A ceramic top which is scratched, chipped, chemically etched or otherwise damaged must not be used



Operating Conditions

Hotplates and stirrers are designed for safe functioning under the following conditions:

- For indoor use in a well ventilated area
- Ensure equipment is used on a dry, non-combustible, solid work surface with at least 300mm suitable clearance all around from other equipment
- Ambient temperature +5°C to +40°C
- Altitude up to 2000m
- Relative humidity not exceeding 80% for temperatures up to 31°C decreasing linearly to 50% relative humidity at 40°C
- Mains supply fluctuations not exceeding 10% of nominal
- Energy-consuming equipment to be supplied from the fixed installation: Over-voltage category II
- Pollution degree 2



- This equipment is not designed to be used in hazardous atmospheres or with hazardous materials
- Following a mains interruption the unit will not restart

Unpacking & Contents

Catalogue Number Coding Description

A catalogue number for each type of hotplate is descriptive. The method of coding is as follows:



SS150X/120

PLATE SURFACE

S = Aluminium
(Stainless steel if stirrer only)
C = Ceramic

INTERFACE

S = Standard Analogue
D = Digital

FUNCTION

150 = Hotplate
151 = Stirrer (analogue interface only)
152 = Hotplate/Stirrer

VOLTAGE

* No Character = 230V
/120 = 120V

COLOUR

B = Blue
W = White
K = Black

* the Analogue Stirrer is dual 230/120V

Product Identification

Digital Hotplate / Stirrer - 230VAC

Colour	Metal (Aluminium)	Ceramic
Blue	SD152B	CD152B
White	SD152W	CD152W
Black	SD152K	CD152K

Digital Hotplate - 230VAC

Colour	Metal (Aluminium)	Ceramic
Blue	SD150B	CD152B
White	SD150W	CD152W
Black	SD150K	CD152K

Analogue Hotplate / Stirrer - 230VAC

Colour	Metal (Aluminium)	Ceramic
Blue	SS152B	CS152B
White	SS152W	CS152W
Black	SS152K	CS152K

Analogue Hotplate - 230VAC

Colour	Metal (Aluminium)	Ceramic
Blue	SS150B	CD152B
White	SS150W	CD152W
Black	SS150K	CD152K

Analogue Stirrer - 100 - 240 VAC

Colour	Metal (Stainless Steel)	Ceramic
Blue	SS151B	CS151B
White	SS151W	CS151W
Black	SS151K	CS151K

Digital Hotplate / Stirrer - 120VAC

Colour	Metal (Aluminium)	Ceramic
Blue	SD152B/120	CD152B/120
White	SD152W/120	CD152W/120
Black	SD152K/120	CD152K/120

Digital Hotplate - 120VAC

Colour	Metal (Aluminium)	Ceramic
Blue	SD150B/120	CD150B/120
White	SD150W/120	CD150W/120
Black	SD150K/120	CD150K/120

Analogue Hotplate / Stirrer - 120VAC

Colour	Metal (Aluminium)	Ceramic
Blue	SS152B/120	CS152B/120
White	SS152W/120	CS152W/120
Black	SS152K/120	CS152K/120

Analogue Hotplate - 120VAC

Colour	Metal (Aluminium)	Ceramic
Blue	SS150B/120	CS150B/120
White	SS150W/120	CS150W/120
Black	SS150K/120	CS150K/120



What's Included in the box

- Instruction book
- Mains moulded plug - hot (UK and EURO variants) or hot US variant
- Stuart Hotplate product
- Stir bar x 2 (HH114) - supplied with stirring variants only
- Warranty card
- Important notice leaflet - supplied with heating variants only



Electrical Installation



THIS EQUIPMENT MUST BE EARTHED

BEFORE CONNECTION PLEASE ENSURE THAT THE LINE SUPPLY CORRESPONDS TO THAT SHOWN ON THE RATING PLATE LOCATED ON THE OUTER CASE

NOTE: Refer to the equipment rating plate to ensure that the plug and fusing are suitable for the voltage and wattage stated.

The wires in the mains cable are coloured as follows:

BROWN - LIVE

BLUE - NEUTRAL

GREEN/YELLOW - EARTH

Should the mains lead need replacement, a cable of 1mm² of harmonised code H05RR-F or H05RN-F connected to an IEC hot condition plug should be used.

IF IN DOUBT CONSULT A QUALIFIED ELECTRICIAN

American mains wire colours required (section Electrical Installation)

Black - LIVE

White - NEUTRAL

Green - EARTH/GROUND



Product Connections

1. IEC power socket - connect the mains supply cable into this socket
2. DIN socket - Connect the optional External temperature controller into this connector

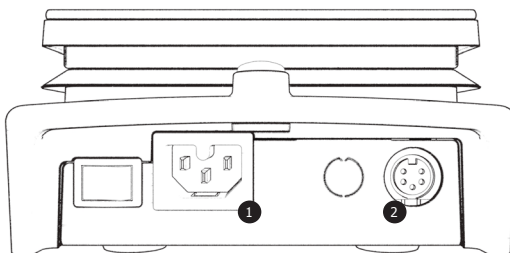

Connect To The External Controller

1. Turn the hotplate mains switch to the OFF position at the rear of the hotplate
2. Disconnect the mains cable from the IEC socket
3. Connect the SCT1 controller plug to the DIN probe socket at the rear of the hotplate
4. Connect the probe plug to the probe socket at the rear of the controller and tighten the locking collar
5. Connect the mains supply lead to the IEC socket
6. The product is now ready for use with the external temperature controller (SCT1)

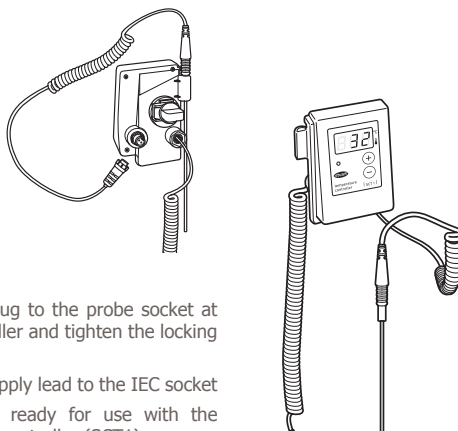

N.B. The SCT1 controller power is supplied by the hotplate

Ceramic Hotplate Hot Zone

When using the ceramic hotplates at temperatures over 180°C, the base of any vessel must not make contact with the ceramic plate top outside of the hot-zone - this is to avoid damaging the ceramic hotplate surface

Note: Modular heating blocks are not suitable for use with ceramic top hotplates

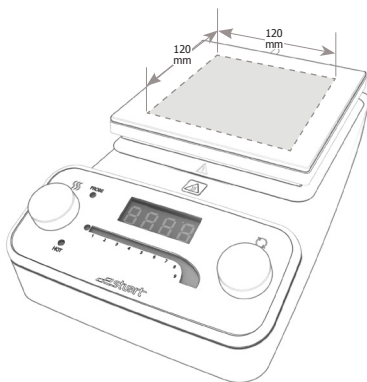

Analogue Stirrer

(SS151, CS151)

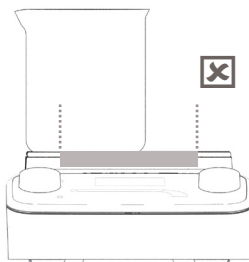
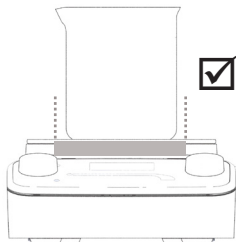

1. Top casting (blue, white or black)
2. Control interface
3. Ceramic top plate
4. Stainless steel top plate
5. Stirrer control dial
6. Analogue stirrer LED display
7. Mains on/off switch
8. IEC power socket
9. DIN socket
10. Retort rod fitting

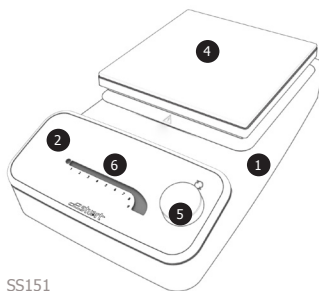

SS151

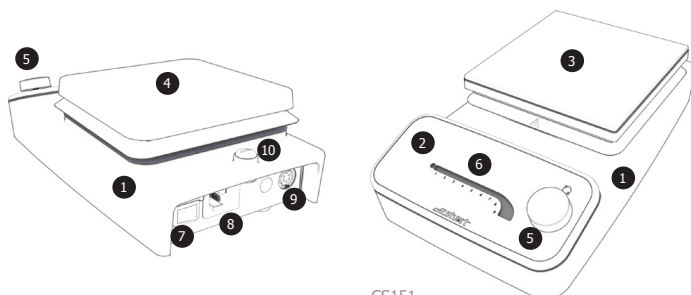

CS151

Product Control & Indicators

- a. Stirrer control dial - When the dial is pushed in the stirrer will remain stationary (LED illuminated but dimly). The stir speed dial controls the stirring speed, the dial is graduated and each graduation is approximately 50 rpm
- b. Analogue stirrer LED display - There is an arbitrary scale (1 -9) with 9 LEDs and each segment is either dim, normal or bright as you graduate the control dial (approximately 50 rpm) . Turning the knob to the higher number increases the stirrer speed (the maximum speed is 1250 rpm (ceramic) to 1400 rpm (metal) when scale 9 LED is illuminated fully)

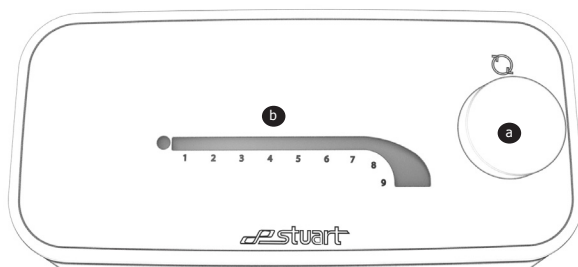

Instructions for Use

- Place a glass vessel with the solution to be stirred in the centre of the hotplate surface
- Place the correct size stir bar into the vessel
- Insert the mains plug into the IEC socket at the rear of the unit
- Switch the unit on using the mains on/off switch at the rear of the unit
- If the LED is dimly illuminated the stirrer remains stationary. Press the dial to turn the stirrer function on

- Turn the graduated stirrer control dial until the analogue is at the desired speed. The current set-point LEDs will flash to confirm the speed has been stored and revert back the actual speed
- When the process is complete, press the stirrer control dial to stop the stirring function
- Allow the stir bar to stop rotating before removing the vessel from the unit

Analogue Hotplate

SS150, SS150/120, CS150, CS150/120

1. Top casting (blue, white or black)
2. Control interface
3. Ceramic top plate
4. Aluminium top plate
5. Stirrer control dial
6. Analogue heater LED display
7. Hot LED
8. Probe LED
9. Mains on/off switch
10. IEC power socket
11. DIN socket
12. Retort rod fitting

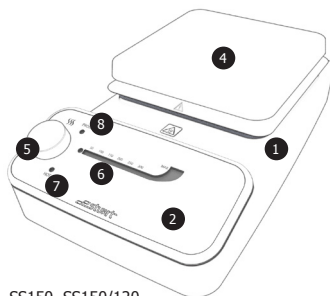

SS150, SS150/120

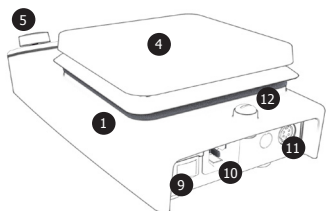

CS150, CS150/120

Product Control & Indicators

- Heater control dial - When the dial is pushed in the heater will be turned off (LED illuminated but dimly). It also controls the heating of the hotplate. For the metal (aluminium) hotplate, the temperature range is from 0 to 325°C and for the ceramic hotplate, the temperature range is from 0 to 450°C
- Analogue heater LED display - For both metal (aluminium) and ceramic units for temperatures 0 to 300°C, when each segment is fully illuminated the temperature will increase 50°C. On the metal (aluminium) unit, for temperatures between 300 to 325 °C, it will be fully illuminated when the temperature is at its maximum 325°C. For the ceramic unit for temperatures 300 to 450 °C, each of the three

segments is fully illuminated the temperature will increase 50°C

- c. Hot LED - this LED will flash when the top plate becomes too hot to touch and while the plate temperature is above 50°C for up to 30 minutes even if the unit is disconnected from the electricity supply
- d. Probe LED - when the SCT1 external controller is plugged into the DIN socket, the probe LED will illuminate

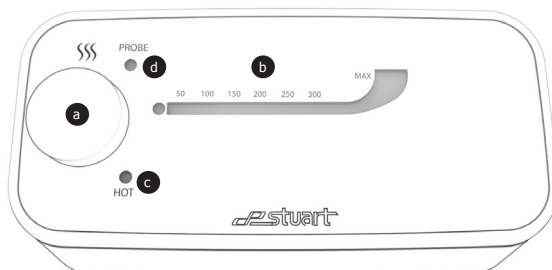

Instructions for use

- Place a vessel with the solution to be heated in the centre of the top plate
- Insert the IEC plug into the IEC socket at the rear of the unit
- Switch the unit on using the mains on/off switch at the rear of the unit
- If the LED next to the analogue heater LED is dimly illuminated the heater is off. Press the dial to turn the heating function on
- Turn the graduated heater control dial until the hockey stick display reads the desired temperature. The current set-point LED's will flash to confirm the new temperature has been stored and revert back the actual temperature. The scale refers to the temperature of the hotplate and not the temperature of the contents
- When the process is complete, press the heater control dial to stop the heating function
- Remove the vessel from the unit once cooled

Analogue Hotplate Stirrer

SS152, SS152/120, CS152, CS152/120

1. Top casting (blue, white or black)
2. Control interface
3. Ceramic top plate
4. Aluminium top plate
5. Stirrer control dial
6. Analogue heater LED display
7. Stirrer control dial
8. Analogue stirrer LED display
9. Hot LED
10. Probe LED
11. Mains on/off switch
12. IEC power socket
13. DIN socket
14. Retort rod fitting

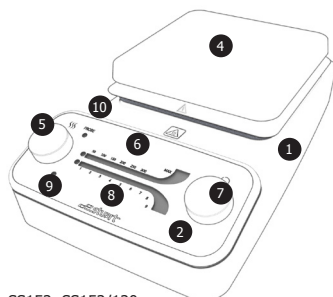

SS152, SS152/120

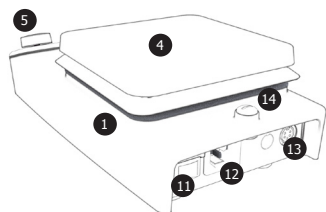

CS152, CS152/120

Product Control and Indicators

- a. Stirrer control dial - When the dial is pushed in the stirrer will remain stationary (LED illuminated but dimly). The stir speed dial controls the stirring speed, the dial is graduated and each graduation is approximately 75 rpm
- b. Analogue stirrer LED display - There is an arbitrary scale (1 - 9) with 9 LEDs and each segment is either dim, normal or bright as you graduate the control dial (approximately 50 rpm). Turning the knob to the higher number increases the stirrer speed (the maximum speed is 1250rpm (ceramic) to 1400rpm (metal) when scale 9 LED is illuminated fully)
- a. Heater control dial - When the dial is pushed in the heater will be turned off (LED illuminated but dimly). It also controls the heating of the hotplate. For the metal (aluminium) hotplate, the temperature range is from 0 to 325°C and for the ceramic hotplate, the temperature range is from 0 to 450°C
- b. Analogue heater LED display - For both metal (aluminium) and ceramic units for temperatures 0 to 300°C, when each segment is fully illuminated the temperature will increase 50°C

- c. Hot LED - this LED will flash when the top plate becomes too hot to touch and while the plate temperature is above 50°C for up to 30 minutes even if the unit is disconnected from the electricity supply
- d. Probe LED - when the SCT1 external controller is plugged into the DIN socket, the probe LED will illuminate

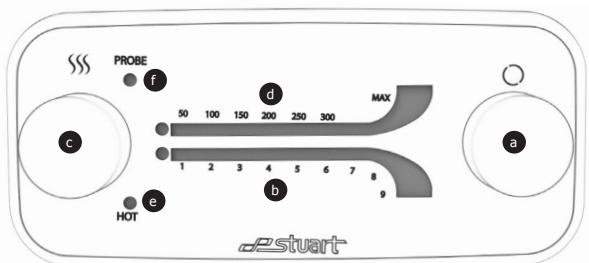

Instructions for Use

- Place a vessel with the solution to be heated in the centre of the top plate
- Insert the IEC plug into the IEC socket at the rear of the unit
- Switch the unit on using the mains on/off switch at the rear of the unit
- If the LED is dimly illuminated the stirrer remains stationary. Press the dial to turn the stirrer function on
- Turn the graduated stirrer control dial until the analogue display reads the desired speed. The current set-point LEDs will flash to confirm the speed has been stored and revert back the actual speed
- If the LED next to the analogue heater LED is dimly illuminated the heater is off. Press the dial to turn the heating function on
- Turn the graduated heater control dial until the analogue display reads the desired temperature. The current set-point LEDs will flash to confirm the new temperature has been stored and revert back to the actual temperature. The scale refers to the temperature of the hotplate and not the temperature of the contents
- When the process is complete, press the stirrer control dial to stop the stirring function and press the heater control dial to stop the heating function.
- Remove the vessel from the unit once cooled

Digital Hotplate

SD150, SD150/120, CD150, CD150/120

1. Top casting (blue, white or black)
2. Control interface
3. Ceramic top plate
4. Aluminium top plate
5. Heater control dial
6. Digital display
7. Hot LED
8. Probe LED
9. Mains on/off switch
10. IEC power socket
11. DIN socket
12. Retort rod fitting

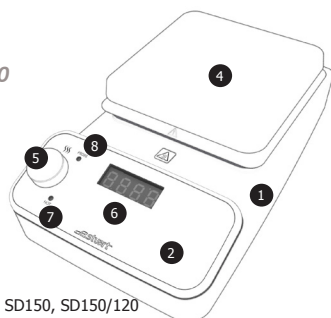

SD150, SD150/120

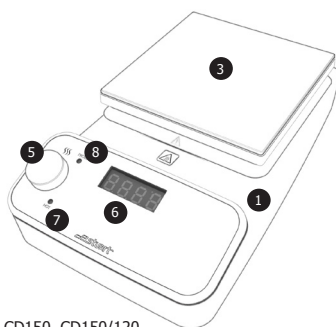

CD150, CD150/120

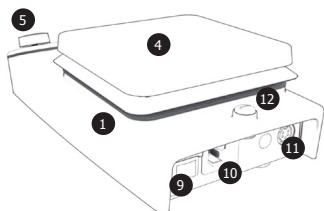

Product Control and Indicators

- a. Heater control dial - When the dial is pushed in the heater will be turned off and the display will display an alternating OFF message on the screen. It also controls the heating and cooling of the hotplate. The knob is graduated and increases in 5°C steps throughout the temperature range
- b. Digital display - will display an alternating OFF message on the screen when the heater is turned off. It will also display an alternating HOT message when the plate temperature is above 50°C. When you turn the unit on the unit should be set to minimum set-point which is 25°C. Adjusting the graduated dial will increase the temperature in 5°C steps throughout the temperature range. When you select a set-point temperature, the temperature set will flash to indicate it is stored and revert back to the current temperature
- c. Hot LED - this LED will flash when the top plate becomes too hot to touch and while the plate temperature is above 50°C for up to 30 minutes even if the unit is disconnected from the electricity supply
- d. Probe LED - when the SCT1 external controller is plugged into the DIN socket, the probe LED will illuminate

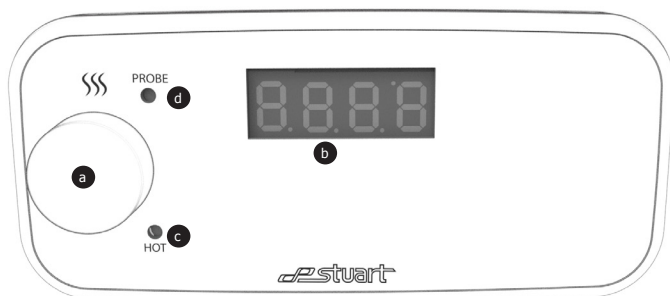

Instructions for use

- Place a charged, clean glass vessel with the solution to be heated in the centre of the top plate
- Insert the IEC plug into the IEC socket at the rear of the unit
- Switch the unit on using the mains on/off switch at the rear of the unit
- If the heater function is turned off, (alternating OFF message on the display), press the heater dial to turn on the heating function
- Turn the graduated heater control dial until the display reads the desired temperature (increases in 5°C increments). The current set-point display will flash to confirm the new temperature has been stored and revert back the actual temperature. The scale refers to the temperature of the hotplate and not the temperature of the contents
- When the process is complete, press the heater control dial to stop the heating function.
- Remove the vessel from the unit once cooled

Digital Hotplate Stirrer

SD152, SD152/120, CD152, CD152/120

1. Top casting (blue, white or black)
2. Control interface
3. Ceramic top plate
4. Aluminium top plate
5. Stirrer control dial
6. Digital Display
7. Analogue stirrer dial
8. Analogue stirrer LED display
9. Hot LED
10. Probe LED

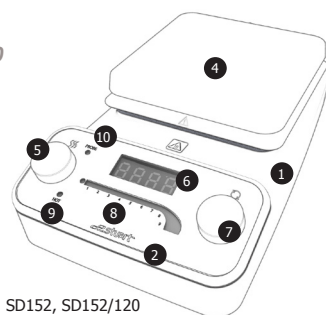

SD152, SD152/120

11. Mains on/off switch
12. IEC power socket
13. DIN socket
14. Retort rod fitting

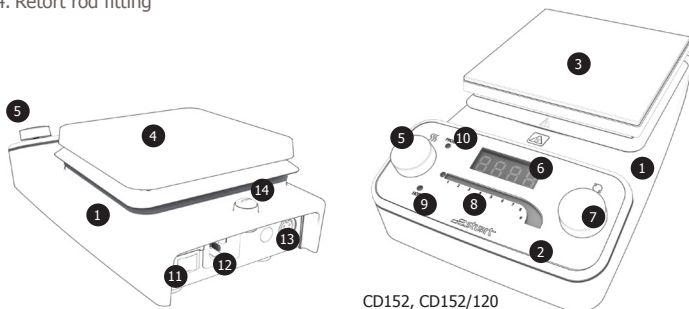

CD152, CD152/120

Product Control and Indicators

- a. Stirrer control dial - When the dial is pushed in the stirrer will remain stationary (LED illuminated but dimly). It also controls the stir speed (clockwise direction only). The knob is graduated and each graduation is approximately 75 rpm
- b. Analogue stirrer LED display - There is an arbitrary scale (1 -9) with 9 LED's and each segment is either dim, normal or bright as you graduate the control dial (approximately 50 rpm) . Turning the knob to the higher number increases the stirrer speed (the maximum speed is 1250rpm (ceramic) to 1400rpm (metal) when scale 9 LED is illuminated fully)
- c. Heater control dial - When the dial is pushed in the heater will be turned off and the display will display an alternating OFF message on the screen. It also controls the heating and cooling of the hotplate. The knob is graduated and increases in 5°C steps throughout the temperature range
- d. Digital display - will display an alternating OFF message on the screen when the heater is turned off. It will also display an alternating HOT message when the plate temperature is above 50°C. When you turn the unit on the unit should be set to minimum set-point which is 25°C. Adjusting the graduated dial will increase the temperature in 5°C steps throughout the temperature range. When you select a set-point temperature, the temperature set will flash to indicate it is stored and revert back to the current temperature
- e. Hot LED - this LED will flash when the top plate becomes too hot to touch and while the plate temperature is above 50°C for up to 30 minutes even if the unit is disconnected from the electricity supply
- f. Probe LED - when the SCT1 external controller is plugged into the DIN socket, the probe LED will illuminate

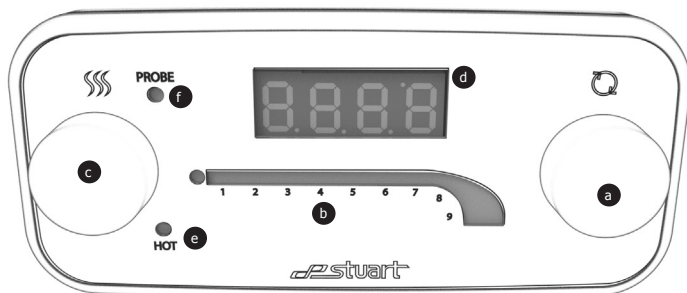

Instructions for use

- Place a vessel with the solution to be heated in the centre of the top plate
- Insert the IEC plug into the IEC socket at the rear of the unit
- Switch the unit on using the mains on/off switch at the rear of the unit
- If the LED is dimly illuminated the stirrer remains stationary. Press the dial to turn the stirrer function on
- Turn the stirrer control dial until the Analogue display reads the desired speed. The current set-point LEDs will flash to confirm the speed has been stored and revert back the actual speed
- If the heater function is turned off, (alternating OFF message on the display), press the heater dial to turn on the heating function
- Turn the graduated heater control dial until the display reads the desired temperature (increases in 5°C increments). The current set-point display will flash to confirm the new temperature has been stored and revert back the actual temperature. The scale refers to the temperature of the hotplate and not the temperature of the contents
- When the process is complete, press the stirrer control dial to stop the stirring function and press the heater control dial to stop the heating function.
- Allow the stir bar to stop rotating and solution to cool down before removing the vessel from the unit

External Controller (SCT1)

The SCT1 temperature controller allows accurate temperature control of aqueous and oil based samples in the laboratory and can be used in two different modes:

- As a precise temperature controller from 20 to 200°C
- Digital thermometer from -4 to 325°C



Control Mode

The heat control of the hotplate is disabled, allowing precise control of the sample temperature via the SCT1 temperature controller. The probe illuminated LED indicates communication between the SCT1 and the hotplate

Digital Thermometer

The SCT1 operates as a digital thermometer and the hotplate temperature is controlled by the heater control dial on the hotplate and refer to the surface temperature of the hotplate not the sample

Troubleshooting

The following error codes are displayed if the instrument detects an error condition. On the digital models the errors are shown as Er1, Er2, etc. on the display. On the analogue models the Er1 condition is shown by flashing the fifth LED on the temperature scale, Er2 would be shown by flashing the fourth LED and so on. Errors Er6 and Er9 are non-fatal errors

- Er1 – Probe Range Error – If SCT1 reports probe temperature of >325°C or < -99°C
- Er2 – SCT1 Box Lost Error – Communications with the SCT1 have been lost.
- Er3 – Hotplate Temperature Error – If the hotplate measures its temperature > 585°C or < -9.9°C
- Er4 – Hotplate Ambient Error – If the temperature sensed inside the unit (not the plate temperature) is too hot
- Er5 – SCT1 Character Error – An unknown character was received from the SCT1.
- Er7 – Probe Out Error – The instrument detects that the SCT1 probe has been removed from the solution being heated
- Er8 – SCT1 Time-out Error – The SCT1 did not respond to a request in the required time.
- Er10 - fatal error tag

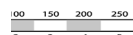
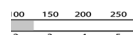
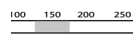
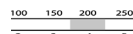
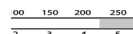



Product Repair

There are no direct user serviceable components inside this series of products. A list of available replacement parts are available on page 19

Please contact Cole-Parmer or your local distributor for repair or maintenance issues



Product Maintenance

Disconnect power to the product by unplugging the power cord before performing any maintenance or inspection

General

Inspect the power cord regularly and replace if damaged. Use only replacement power cords available from Cole-Parmer. The unit is fitted with a hot condition IEC socket for fitting to the mains supply (always use correct power cord)

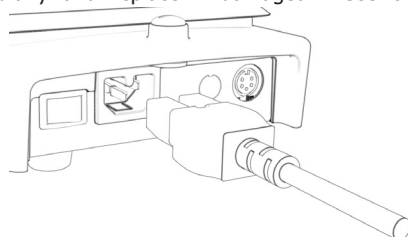

Fuse Replacement

The dual mains fuses are located inside the unit and are not user replaceable parts

General Cleaning

- Ensure the top plate is cool and the unit is disconnected from the mains electricity supply
- It is important to keep the product clean and dry
- Remove any exterior liquid spills promptly
- Clean exterior surfaces with a damp cloth and a mild detergent solution
- Do not re-connect to power until all cleaned surfaces are dry
- If liquid gets inside the product, immediately disconnect power to the product and discontinue use. Contact Cole-Parmer for additional instructions regarding interior spills



Ceramic Top Plate Cleaning

- The ceramic top is highly resistant to chemical attack
- Ensure the top plate is cool and disconnect from the mains electricity
- A damp cloth will normally remove most types of contamination. For more difficult stains a domestic cream cleanser is recommended
- During cleaning and general operation take care not to scratch the surface as this could cause thermal breakage
- A ceramic top which is scratched, chipped, chemically etched or otherwise damaged must not be used



Optional Accessories

Full Hotplate Range (excluding the Analogue Stirrers SS151, CS151)

Part Number	Description	Quantity
SR1	Retort rod, 600mm x 12mm diameter	1
SCT1	Temperature controller	1

Metal (aluminium) Hotplates and Stirrers Only

A complete range of modular heating blocks for heating round bottom flasks is available for use with metal top hotplates. See the Stuart website for further information

Footnote:

Modular heating blocks are not suitable for use with ceramic top hotplates

Replacement Parts

Only spare parts supplied by Cole-Parmer or its agent should be used. Fitting of non-approved parts may affect the performance of the safety features of the product

Replacement Parts

Part Number	Description	Quantity
US152021	UK Mains Cord Moulded Plug (Hot)	1
US152023	EURO Mains Cord Moulded Plug (Hot)	1
BSSEP013	US Mains Cord Moulded Plug (Hot)	1



Technical Specifications



Hotplate Stirrers	SD152 & /120	CD152 & /120	SS152 & /120	CS152 & /120
Plate material	Coated aluminium/ silicon	Glass ceramic	Coated aluminium/ silicon	Glass ceramic
Plate dimensions, mm	150 x 150	150 x 150	150 x 150	150 x 150
Heated area, mm	150 x 150	120 x 120	150 x 150	120 x 120
Heater control	Digital	Digital	Analogue	Analogue
Heater power, W	700	500	700	500
Max.plate temp, °C	325	450	325	450
Stirrer speed, rpm	50 - 1400	50 - 1250	50 - 1400	50 - 1250
Max. stirring capacity, L*	15	15	15	15
Compatible with SCT1	Yes	Yes	Yes	Yes
Control accuracy with SCT1	± 1°C	± 1°C	± 1°C	± 1°C
Dimensions (wxdxh), mm	182 x 300 x 90	182 x 300 x 85	182 x 300 x 90	182 x 300 x 85
Net weight, kg	2.73	2.68	2.73	2.68
Power, W	750/920	550/650	750/920	550/650
Electrical supply	120V, 60Hz, 230V, 50Hz	120V, 60Hz, 230V, 50Hz	120V, 60Hz, 230V, 50Hz	120V, 60Hz, 230V, 50Hz

Hotplates	SD150 & /120	CD150 & /120	SS150 & /120	CS150 & /120
Plate material	Coated aluminium/ silicon	Glass ceramic	Coated aluminium/ silicon	Glass ceramic
Plate dimensions, mm	150 x 150	150 x 150	150 x 150	150 x 150
Heated area, mm	150 x 150	120 x 120	150 x 150	120 x 120
Heater control	Digital	Digital	Analogue	Analogue
Heater power, W	700	500	700	500
Max.plate temp, °C	325	450	325	450
Max. stirring capacity, L*	15	15	15	15
Compatible with SCT1	Yes	Yes	Yes	Yes
Control accuracy with SCT1	± 1°C	± 1°C	± 1°C	± 1°C
Dimensions (wxdxh), mm	182 x 300 x 90	182 x 300 x 85	182 x 300 x 90	182 x 300 x 85
Net weight, kg	2.31	2.26	2.31	2.26
Power, W	750/920	550/650	750/920	550/650
Electrical supply	120V, 60Hz, 230V, 50Hz	120V, 60Hz, 230V, 50Hz	120V, 60Hz, 230V, 50Hz	120V, 60Hz, 230V, 50Hz

Stirrers	SS151	CS151
Plate material	Stainless Steel	Glass ceramic
Plate dimensions, mm	150 x 150	150 x 150
Stirrer speed, rpm	50 - 1400	50 - 1250
Max. stirring capacity, L*	15	15
Dimensions (wxdxh), mm	182 x 300 x 75	182 x 300 x 85
Net weight, kg	2.29	2.29
Power, W	4	4
Electrical supply	100-240V	100-240V



CE Declaration of Conformity

Available for viewing on the Stuart website

Product Disposal

The 'crossed wheelie bin' symbol present on the product indicates that the product was planned for use in a country complying with the Waste Electrical and Electronic Equipment (WEEE) EU directive 2012/19/EU. This symbol indicates that the equipment must not be discarded as domestic waste. This product should only be dismantled for recycling by an authorised recycling company. It is the product user's responsibility to decontaminate waste equipment from biological, chemical and/or radiological hazards prior to disposal



Packaging material has been selected such that it may be sorted for recycling

If the equipment has been exposed to contamination, appropriate decontamination certificate is required



If this product or any part of the unit becomes damaged or requires servicing, the product should be returned with a decontamination certificate

Warranty Statement

Cole-Parmer warrants this equipment to be free from defects in material and workmanship when used under normal laboratory conditions for a period of 3 years. This warranty begins from the date of purchase by the end user

In the event of a justified claim, Cole-Parmer will replace any defective component or replace the unit free of charge

This warranty does NOT apply if:

- A ceramic top has broken due to mechanical impact, scratching, chipping or chemical etching
- Any repair has been made or attempted other than by Cole-Parmer or its agents
- Minor coating chips and scratches appear from what is deemed normal use
- Damage caused by fire, accident, misuse, neglect, incorrect adjustment or repair, damage caused by installation, adaptation, modification or fitting non-approved parts



Your Purchase Record

Cole-Parmer recommends that you record the details of your purchase in the spaces below for your future reference



Model Number _____ *Serial Number* _____

Date Purchased ___ / ___ / ___

Purchased From _____

Purchase Reference Number _____

Customer Support

For help and support in using this product please contact Customer Services at the following address



Cole-Parmer
Beacon Road
Stone
Staffordshire
ST15 0SA
United Kingdom

Tel.: +44(0)1785 812121
Email: cpinfo@coleparmer.com

 **stuart**[®]

 **Cole-Parmer**[®]