

Instruction Manual

HI8633 HI8733 - HI8734

**Reliable and Waterproof
Multi-Range
Conductivity Meters**

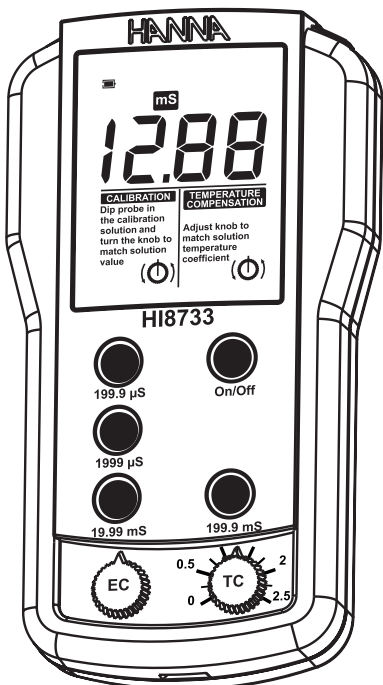

Dear Customer,

Thank you for choosing a Hanna Instruments product.

Please read this instruction manual carefully before using these instruments.

This manual will provide you with the necessary information for correct use of these instruments, as well as a precise idea of their versatility.

If you need additional technical information, do not hesitate to e-mail us at tech@hannainst.com or view our worldwide contact list at www.hannainst.com.

All rights are reserved. Reproduction in whole or in part is prohibited without the written consent of the copyright owner.

TABLE OF CONTENTS

PRELIMINARY EXAMINATION	4
GENERAL DESCRIPTION	4
FUNCTIONAL DESCRIPTION & SPECIFICATIONS OF HI8633	5
FUNCTIONAL DESCRIPTION & SPECIFICATIONS OF HI8733	6
FUNCTIONAL DESCRIPTION & SPECIFICATIONS OF HI8734	7
OPERATIONAL GUIDE	8
CALIBRATION	9
CONDUCTIVITY VERSUS TEMPERATURE CHART.....	13
TDS VERSUS TEMPERATURE CHART	14
DETERMINING THE TEMPERATURE COEFFICIENT OF A SOLUTION (HI8733)....	15
BATTERY REPLACEMENT	16
PROBE MAINTENANCE	17
ACCESSORIES.....	18

PRELIMINARY EXAMINATION

Remove the instrument from the packing material and examine it carefully to make sure that no damage has occurred during shipping. If there is any noticeable damage, please contact your local Hanna Instruments Office.

Each meter is supplied with:

- Conductivity probe with DIN connector and 1 m (3.3') cable:
 - **HI76301D** for **HI8633** and **HI8734**
 - **HI76302W** for **HI8733**
- Calibration solution sachet
- Instruction manual
- Quality Certificate
- 9V alkaline battery (1 pc.)

Note: Save all packing materials until you are sure that the instrument functions correctly. Any damaged or defective item must be returned in its original packing materials together with the supplied accessories.

GENERAL DESCRIPTION

HI 8633 and **HI 8733** have been designed specifically for use in the areas of production and quality control. It is often necessary to test samples with different concentrations ranging from deionized water to brine.

Both models can be manually calibrated at 1 point.

The **HI8733**, with a built-in temperature sensor and Automatic Temperature Compensation, is the perfect instrument for measuring samples with fluctuating temperature.

HI8734 has been specially designed for the water conditioning industry, particularly in the softening, demineralization, reverse osmosis and drinking water applications.

Three ranges of measurement assure the highest accuracy possible. In addition, Manual Temperature Compensation is possible through a knob on the front panel.

The ratio between conductivity and TDS is factory set at 0.5.

Moreover, the 4-ring potentiometric probes supplied with the meters are made of rugged PVC - ideal for indoor, as well as outdoor measurements.

FUNCTIONAL DESCRIPTION & SPECIFICATIONS OF HI8633

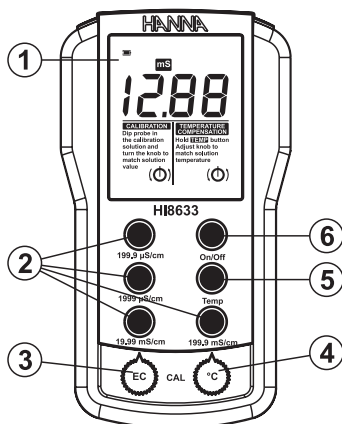

- 1) Liquid Crystal Display
- 2) Measurement range selection keys
- 3) EC calibration knob
- 4) Manual temperature compensation knob
- 5) Temperature selection key
- 6) On/Off key

Range	0.0 to 199.9 / 0 to 1999 $\mu\text{S}/\text{cm}$ 0.00 to 19.99 / 0.0 to 199.9 mS/cm
Resolution	0.1 / 1 $\mu\text{S}/\text{cm}$ 0.01 / 0.1 mS/cm
Accuracy (@ 20 °C/68 °F)	$\pm 1\%$ Full scale excluding probe error
Typical EMC Deviation	$\pm 2\%$ Full Scale
Calibration	Manual, 1 point, through EC knob
Temperature Compensation	Manual, 0 to 50 °C (32 to 122 °F) with $\beta = 2\% / ^\circ\text{C}$
Probe (included)	HI76301D with 1m (3.3') cable
Environment	0 to 50 °C (32 to 122 °F); RH max 100%
Battery Type	1 x 9V alkaline
Battery Life	Approx. 100 hours of continuous use
Dimensions	145 x 80 x 36 mm (5.7 x 3.1 x 1.4 ")
Weight	230 g (8.1 oz.)

FUNCTIONAL DESCRIPTION & SPECIFICATIONS OF HI8733

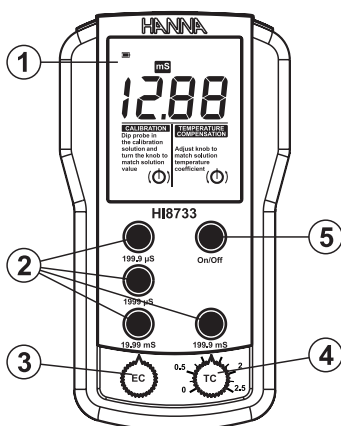

- 1) Liquid Crystal Display
- 2) Measurement range selection keys
- 3) EC calibration knob
- 4) Automatic Temperature Compensation coefficient knob
- 5) On/Off key

Range	0.0 to 199.9 / 0 to 1999 $\mu\text{S}/\text{cm}$ 0.00 to 19.99 / 0.0 to 199.9 mS/cm
Resolution	0.1 / 1 $\mu\text{S}/\text{cm}$ 0.01 / 0.1 mS/cm
Accuracy (@ 20 °C/68 °F)	$\pm 1\%$ Full scale excluding probe error
Typical EMC Deviation	$\pm 2\%$ Full Scale
Calibration	Manual, 1 point, through EC knob
Temperature Compensation	Automatic, 0 to 50 °C (32 to 122 °F) with β adjustable from 0 to 2.5%/°C
Probe (included)	HI76302W ATC with 1m (3.3') cable
Environment	0 to 50 °C (32 to 122 °F); RH max 100%
Battery Type	1 x 9V alkaline
Battery Life	Approx. 100 hours of continuous use
Dimensions	145 x 80 x 36 mm (5.7 x 3.1 x 1.4 ")
Weight	230 g (8.1 oz.)

FUNCTIONAL DESCRIPTION & SPECIFICATIONS OF HI8734

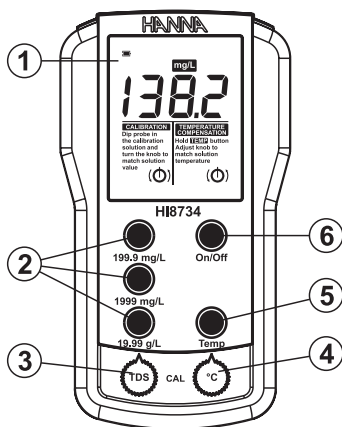

- 1) Liquid Crystal Display
- 2) Measurement range selection keys
- 3) TDS calibration knob
- 4) Manual temperature compensation knob
- 5) Temperature selection key
- 6) On/Off key

Range	0.0 to 199.9 / 0 to 1999 mg/L 0.00 to 19.99 g/L
Resolution	0.1 / 1 mg/L 0.01 g/L
Accuracy (@ 20 °C/68 °F)	±1% Full scale excluding probe error
Typical EMC Deviation	±2% Full Scale
Calibration	Manual, 1 point, through TDS knob
Temperature Compensation	Manual, 0 to 50 °C (32 to 122 °F) with $\beta = 2\%/^{\circ}\text{C}$
Probe (included)	HI76301D with 1m (3.3') cable
Environment	0 to 50 °C (32 to 122 °F); RH max 100%
Battery Type	1 x 9V alkaline
Battery Life	Approx. 100 hours of continuous use
Dimensions	145 x 80 x 36 mm (5.7 x 3.1 x 1.4 ")
Weight	230 g (8.1 oz.)

OPERATIONAL GUIDE

- Each meter is supplied complete with a 9V battery. Remove the battery compartment cover on the back of the meter (see page 16). Install the battery while observing its polarity.
- Connect the probe to the meter securely by aligning the pins with the socket and pushing the plug in.
- Make sure that the meter has been calibrated before taking any measurements (see "Calibration" section).
- Immerse the conductivity probe into the sample, with the holes on the shaft completely submerged.
If possible, use plastic beakers or containers to minimize any EMC interference.
- Tap the probe lightly on the bottom of the beaker to remove any air bubbles which may be trapped inside the PVC sleeve.
- Turn the instrument on by pressing the **On/Off** key.



For HI8633 and HI8734:

- Take the temperature of the solution with a ChecktempC or another accurate thermometer following LCD indication.
- Press and hold down the **Temp** key to display the temperature and adjust the temperature knob to that of the solution e.g. 20 °C.

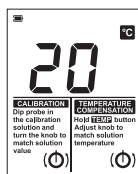

For HI8733:

- Adjust the TEMPERATURE COEFFICIENT knob to 2% to compensate for the temperature effect of average solutions (to determine exact value for a particular solution, see page 15).
- Select the appropriate measurement range.

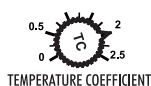

Note: If the display shows only a “1” on the far left hand side, the meter is out of range. Select the next (higher) range.

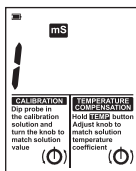

- Wait for a couple of minutes for the temperature sensor to reach thermal equilibrium with the sample before taking measurements.
- After the measurement has been completed, the instrument should be switched off and the probe should be cleaned and dried (see “Probe Maintenance” on page 17).

CALIBRATION

Accessories needed:

- Use any calibration solution within the meter’s range. The solution should ideally be close to the samples being measured. Use for example **HI7030** or **HI8030**, 12880 $\mu\text{S}/\text{cm}$ ($=12.88$ mS/cm) conductivity solution, for **HI8633** and **HI8733**, and **HI7032**, 1382 mg/L ($=2764$ $\mu\text{S}/\text{cm}$) TDS solution, for **HI8734**.
- ChecktempC or another accurate thermometer with 0.1 $^{\circ}\text{C}$ resolution (not necessary for **HI8733**).

PROCEDURE FOR HI8633 AND HI8734

- Pour sufficient quantity of a conductivity (**HI8633**) or TDS (**HI8734**) calibration solution (e.g. **HI7030** or **HI7032**) into a beaker to cover the holes on the probe. If possible, use plastic beakers to minimize any EMC interference.
- Immerse the conductivity probe, making sure that holes are completely submerged, and the ChecktempC in the solution.
- Wait for a couple of minutes for thermal equilibrium to be reached.
- Tap the probe on the bottom, then shake it while rotating to make sure no air bubbles remain trapped in the sleeve.



- Record the temperature of the buffer solution from the thermometer (e.g. 20 °C).

- Switch the instrument on by pressing **On/Off**.



- Press and hold down **Temp** to display the temperature.



- Adjust the TEMPERATURE knob to display 20 °C.

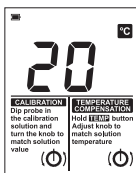

- Release **Temp** key to display conductivity measurement.

- Select 19.99 mS/cm (**HI8633**) or 1999 mg/L (**HI8734**) range by pressing the appropriate range key.



- Follow LCD calibration indication. Adjust the calibration knob until the display shows for **HI8633** the conductivity reading at 25 °C (see the conductivity vs. temperature table), e.g. @ 25 °C, 12880 μS/cm = 12.88 mS/cm, or for **HI8734** the TDS reading at 25 °C (see the TDS vs. temperature chart), e.g. @25 °C, 1382 mg/L.

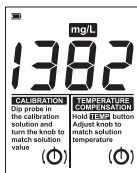
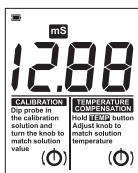

- All subsequent measurements will be compensated to 25 °C (77 °F). If you prefer to standardize the temperature compensation to 20 °C (68 °F) rather than 25 °C (77 °F), leave the TEMPERATURE knob at 18°C (if the temperature of the solution is 18 °C), adjust the knob to read "11.67 mS" (see the conductivity vs. temperature chart) or "1251 mg/L" (see the TDS vs. temperature chart). All subsequent measurements will be compensated to 20 °C.

- The calibration is now complete and the instrument is ready for use.

The instrument should be recalibrated at least once a month, or when the probe is changed.

Note: For more accurate results, it is advisable to use a calibration solution close to the measurement range. See the “Accessories” section for a wide selection of conductivity solutions.

PROCEDURE FOR HI8733

- Pour sufficient quantity of a conductivity calibration solution (e.g. **HI7030/ HI8030**) into a beaker to cover the holes on the probe. If possible, use plastic beakers to minimize any EMC interference.



- Immerse the conductivity probe in the solution, making sure that holes are completely submerged.

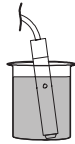

- Wait for a couple of minutes for thermal equilibrium to be reached.

- Tap the probe on the bottom, then shake it while rotating to make sure no air bubbles remain trapped in the sleeve.

- Switch the instrument on by pressing **On/Off**.



- Set the temperature coefficient knob to 2% to compensate for the temperature effect of average solutions (to determine exact value for a particular solution, see page 15).



- Select 19.99 mS/cm range by pressing the appropriate range key.



- Follow LCD calibration indication. Adjust the calibration knob until the display shows “12.88 mS” i.e. the conductivity reading @ 25 °C.

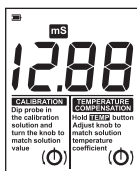

- All subsequent measurements will be compensated to 25 °C (77 °F).

If you prefer to standardize the temperature compensation to 20 °C (68 °F) rather than 25 °C (77 °F), adjust the knob to read “11.67 mS” (see the conductivity vs. temperature chart on page 13). All subsequent measurements will be compensated to 20 °C.

- The calibration is now complete and the instrument is ready for use.

The instrument should be recalibrated at least once a month, or when the probe is changed.

Note: For more accurate results, it is advisable to use a calibration solution close to the range to be measured. See the “Accessories” section for a wide selection of conductivity solutions.

CONDUCTIVITY VERSUS TEMPERATURE CHART

The conductivity of an aqueous solution is the measure of its ability to carry an electrical current by means of ionic motion.

The conductivity invariably increases with increasing temperature.

It is affected by the type and number of ions in the solution and by the viscosity of the solution itself. Both parameters are temperature dependent. The dependency of conductivity on temperature is expressed as a relative change per degree Celsius at a particular temperature, commonly as percent per °C.

°C	°F	HI7030 HI8030 (mS/cm)	HI7031 HI8031 (mS/cm)	HI7033 HI8033 (mS/cm)	HI7034 HI8034 (mS/cm)	HI7035 HI8035 (mS/cm)	HI7039 HI8039 (mS/cm)
0	32	7150	776	64	48300	65400	2760
5	41	8220	896	65	53500	74100	3180
10	50	9330	1020	67	59600	83200	3615
15	59	10480	1147	68	65400	92500	4063
16	60.8	10720	1173	70	67200	94400	4155
17	62.6	10950	1199	71	68500	96300	4245
18	64.4	11190	1225	73	69800	98200	4337
19	66.2	11430	1251	74	71300	100200	4429
20	68	11670	1278	76	72400	102100	4523
21	69.8	11910	1305	78	74000	104000	4617
22	71.6	12150	1332	79	75200	105900	4711
23	73.4	12390	1359	81	76500	107900	4805
24	75.2	12640	1386	82	78300	109800	4902
25	77	12880	1413	84	80000	111800	5000
26	78.8	13130	1440	86	81300	113800	5096
27	80.6	13370	1467	87	83000	115700	5190
28	82.4	13620	1494	89	84900	117700	5286
29	84.2	13870	1521	90	86300	119700	5383
30	86	14120	1548	92	88200	121800	5479
31	87.8	14370	1575	94	90000	123900	5575

For manual temperature compensation, refer to the following chart:

For instance, the conductivity values of the calibration solutions at 25 °C are 12880 $\mu\text{S/cm}$, 1413 $\mu\text{S/cm}$ or 5000 $\mu\text{S/cm}$ when using **HI7030**, **HI7031** or **HI7039**, respectively.

At 20 °C, the values are 11670 $\mu\text{S/cm}$, 1278 $\mu\text{S/cm}$ or 4523 $\mu\text{S/cm}$, respectively. With the solutions at 30 °C, the values are 14120 $\mu\text{S/cm}$, 1548 $\mu\text{S/cm}$ or 5479 $\mu\text{S/cm}$, respectively.

TDS VERSUS TEMPERATURE CHART

The TDS value in aqueous solutions is directly proportional to conductivity. The ratio between the two parameters depends on the solution and usually it is set to a factor of 0.5 (corresponding to a solution of CaCO_3). This means that $1 \mu\text{S}/\text{cm}$ is equal to 0.5 mg/L (ppm) of TDS. For manual temperature compensation, refer to the following chart:

°C	°F	HI7032 mg/L (ppm)	HI7036 g/L (ppt)
0	32	758	6.82
5	41	876	7.88
10	50	999	8.99
15	59	1122	10.10
16	60.8	1148	10.33
17	62.6	1173	10.56
18	64.4	1200	10.78
19	66.2	1224	11.01
20	68	1251	11.24
21	69.8	1277	11.47
22	71.6	1303	11.71
23	73.4	1329	11.94
24	75.2	1358	12.18
25	77	1382	12.41
26	78.8	1408	12.65
27	80.6	1438	12.89
28	82.4	1461	13.13
29	84.2	1476	13.37
30	86	1515	13.61
31	87.8	1541	13.85

For instance, the TDS values of the calibration solutions at $25 \text{ }^\circ\text{C}$ are 1382 mg/L or 12.41 g/L when using **HI7032** or **HI7036**, respectively. At $20 \text{ }^\circ\text{C}$, the values are 1251 mg/L or 11.24 g/L , respectively. With the solutions at $30 \text{ }^\circ\text{C}$, the values are 1515 mg/L or 13.61 g/L , respectively.

DETERMINING THE TEMPERATURE COEFFICIENT OF A SOLUTION (HI8733)

Highly acidic, alkaline samples or solutions with high salt content might have a different coefficient than the customary 2% per degree °C.

In order to calculate this coefficient follow the procedure below:

- Immerse the probe of **HI8733** in the sample and adjust the TEMPERATURE COEFFICIENT knob to 0% (i.e. no compensation).

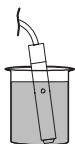

- Condition the sample and probe to 25 °C and note the conductivity reading, C_{25} .
- Condition the sample and probe to a different temperature t °C (approximately 10 °C different from 25 °C) and note the conductivity reading C_t .
- The temperature coefficient β of the solution is calculated as given by the following formula:

$$\beta = 100 \times \frac{(C_t - C_{25})}{(t - 25) \times C_{25}}$$

The above procedure is suitable for determining the temperature coefficient in a laboratory or where the temperature of the solution can be controlled.

If this is not possible (e.g. on-site measurements), the following procedure can be used providing the sample temperature varies by at least 5 °C or preferably 10 °C:

- Immerse the probe of **HI8733** in the test solution and turn the TEMPERATURE COEFFICIENT knob to 0% (no compensation).
- Check the conductivity reading and record the value. Make sure the reading is stable, i.e. no greater variations than ± 0.2 mS/cm within a minute.
- Repeat the procedure when the temperature of the test solution has changed by at least 5 °C. Wait for the conductivity reading to stabilize.
- Adjust the TEMPERATURE COEFFICIENT knob until the display shows the same value as recorded earlier.
- The value indicated by the knob is the temperature coefficient of the solution.

BATTERY REPLACEMENT

When battery becomes weak the meter will display the battery symbol as empty.

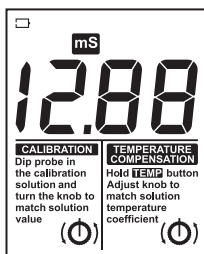

When the low battery indicator appears, the battery has only a few hours left. A low battery will result in unreliable measurements.

It is recommended to replace the battery immediately.

Battery replacement must only take place in a nonhazardous area using a 9V alkaline battery.

Unscrew the three screws on the rear of the meter, remove the battery compartment cover and replace the 9V battery with a new one.

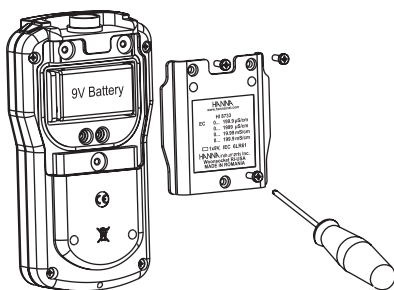

Make sure the battery contacts are tight and secure before replacing the cover.

PROBE MAINTENANCE

Rinse the probe with tap water after every series of measurements. If a more thorough cleaning is required, remove the PVC sleeve and clean the probe with a cloth or a nonabrasive detergent. When reinserting the sleeve onto the probe, be sure that the sleeve is in the right direction with the four holes towards the cable end.

After cleaning the probe, recalibrate the instrument.

The probe body is in PVC. For this reason it must never come into close contact with a heat source. If the probe is exposed to high temperatures (above 50 °C/122 °F), the rings might become loose or detached, resulting in a serious impairment of the probe. In such cases, the probe has to be replaced.

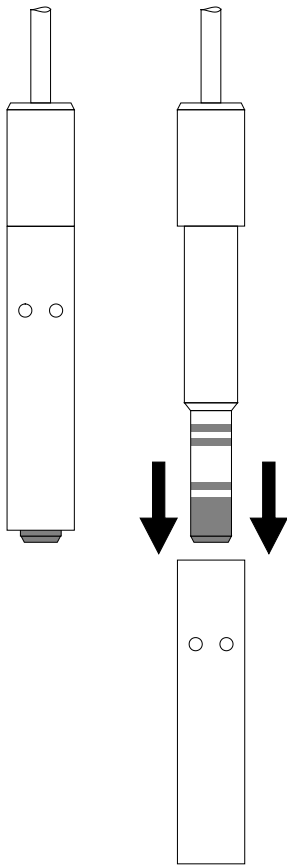

ACCESSORIES

CALIBRATION SOLUTIONS

HI7030L	12880 $\mu\text{S}/\text{cm}$, 500 mL bottle
HI7030M	12880 $\mu\text{S}/\text{cm}$, 230 mL bottle
HI7031L	1413 $\mu\text{S}/\text{cm}$, 500 mL bottle
HI7031M	1413 $\mu\text{S}/\text{cm}$, 230 mL bottle
HI7033L	84 $\mu\text{S}/\text{cm}$, 500 mL bottle
HI7033M	84 $\mu\text{S}/\text{cm}$, 230 mL bottle
HI7034L	80000 $\mu\text{S}/\text{cm}$, 500 mL bottle
HI7034M	80000 $\mu\text{S}/\text{cm}$, 230 mL bottle
HI7035L	111800 $\mu\text{S}/\text{cm}$, 500 mL bottle
HI7035M	111800 $\mu\text{S}/\text{cm}$, 230 mL bottle
HI7039L	5000 $\mu\text{S}/\text{cm}$, 500 mL bottle
HI7039M	5000 $\mu\text{S}/\text{cm}$, 230 mL bottle
HI7032L	1382 ppm (mg/L), 500 mL bottle
HI7032M	1382 ppm (mg/L), 230 mL bottle
HI7036L	12.41 ppt (g/L), 500 mL bottle
HI7036M	12.41 ppt (g/L), 230 mL bottle

CONDUCTIVITY PROBES

HI76301D	Conductivity probe with 1m (3.3') cable and DIN connector
HI76302W	Conductivity probe with built-in temperature sensor, 1m (3.3') cable and DIN connector

OTHER ACCESSORIES

HI98501	Electronic thermometer (range: -50.0 to 150.0°C)
HI710007	Shockproof rubber boot, blue
HI710008	Shockproof rubber boot, orange

RECOMMENDATIONS FOR USERS

Before using this product, make sure it is entirely suitable for your specific application and for the environment in which it is used.

Any variation introduced by the user to the supplied equipment may degrade the meters' performance. For yours and the meter's safety do not use or store the meter in hazardous environments.

WARRANTY

HI8633, **HI8733** and **HI8734** are guaranteed for two years against defects in workmanship and materials when used for their intended purpose and maintained according to instructions. Electrodes and probes are guaranteed for six months. This warranty is limited to repair or replacement free of charge.

Damage due to accidents, misuse, tampering or lack of prescribed maintenance is not covered.

If service is required, contact your local Hanna Instruments Office.

If under warranty, report the model number, date of purchase, serial number and the nature of the problem. If the repair is not covered by the warranty, you will be notified of the charges incurred. If the instrument is to be returned to Hanna Instruments, first obtain a Returned Goods Authorization number from the Technical Service department and then send it with shipping costs prepaid. When shipping any instrument, make sure it is properly packed for complete protection.

Hanna Instruments reserves the right to modify the design, construction and appearance of its products without advance notice.



World Headquarters

Hanna Instruments Inc.
Highland Industrial Park
584 Park East Drive
Woonsocket, RI 02895 USA
www.hannainst.com

Local Office

Hanna Instruments Inc.
Highland Industrial Park
584 Park East Drive
Woonsocket, RI 02895 USA
Phone: 800.426.6287
Fax: 401.765.7575
e-mail: tech@hannainst.com