

# HI766 K-Type Thermocouple Probes

## HI766PX Series, Probes with Detachable Handle

The HI766PX series are K-type thermocouple temperature probes to be used with thermocouple thermometers. These probes are ideal for measuring samples at very high temperatures, such as in industrial applications.

All probes are made of stainless steel for long life and easy cleaning. The HI766PX series includes a wide range of probes for measurement of liquids, air, gas and penetration in semisolids, as well as curved, planed or hard-to-reach surfaces. In addition, models are available with interchangeable or fixed handles for maximum versatility.



## HI766HD, Probe Handle

A rugged, PVC handle with a 1 meter (3.3') cable. It is provided with a female connector, which allows the connection of any HI766Px probe.

## HI766EX, Extension Cable

A coiled cable which extends the probe cable by 1 m (3.3'), with two connectors at the two ends (1 male and 1 female).



## HI766PA, Roller Surface Probe

This probe is designed to measure the temperature of convex surfaces.

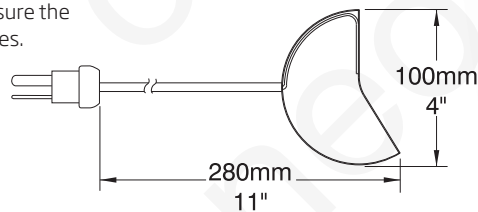

### Specifications

Code	Application	Max. Temperature	Response Time (90% of final value)	Probe Length	Probe
HI766PA	convex surfaces, moving rollers	320°C (600°F)	7 seconds	280 mm (11')	stainless steel

## HI766PB, Surface Probe

Temperature probe for measurements on surfaces.

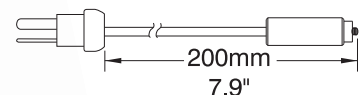

### Specifications

Code	Application	Max. Temperature	Response Time (90% of final value)	Probe Dimensions	Probe
HI766PB	hot solids, furnaces, molds	650°C (1200°F)	8 seconds	L 200 mm x dia 16 mm (7.9 x 0.6")	stainless steel



# HI766 K-Type Thermocouple Probes



## HI766PC, Penetration Probe

K-type thermocouple probe with sharp tip for penetration of semi-solid samples.

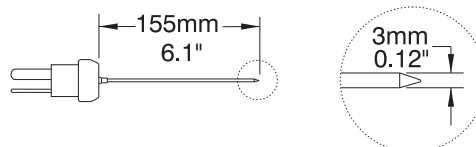

### Specifications

Code	Application	Max. Temperature	Response Time (90% of final value)	Probe Dimensions	Probe
HI766PC	semi-solids, meat, rubber	900°C (1650°F)	15 seconds	L 155 mm x dia 3 mm (6.1 x 0.12")	stainless steel



## HI766PD, Probe for Air and Gas

K-type thermocouple probe for measuring the temperature of air and gases.

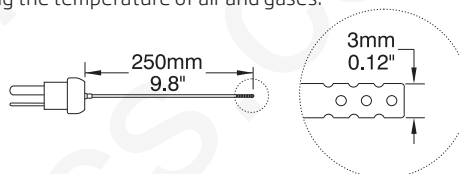

### Specifications

Code	Application	Max. Temperature	Response Time (90% of final value)	Probe Dimensions	Probe
HI766PD	air, gases	300°C (570°F)	20 seconds	L 250 mm x dia 3 mm (9.8 x 0.12")	stainless steel



## HI766PE1, General Purpose Probe

General purpose, penetration probe.

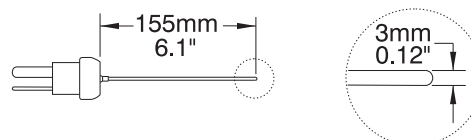

### Specifications

Code	Application	Max. Temperature	Response Time (90% of final value)	Probe Dimensions	Probe
HI766PE1	liquids, air, gases	900°C (1650°F)	6 seconds	L 155 mm x dia 3 mm (6.1 x 0.12")	stainless steel



## HI766PE2, General Purpose Probe

General purpose, penetration probe.

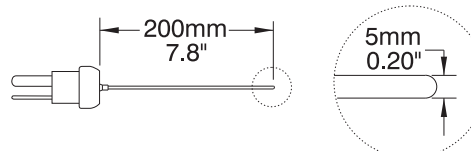

### Specifications

Code	Application	Max. Temperature	Response Time (90% of final value)	Probe Dimensions	Probe
HI766PE2	liquids, air, gases	900°C (1650°F)	6 seconds	L 200 mm x dia 5 mm (7.8 x 0.2")	stainless steel

LINE ID:neonicstool



ติดต่อบริษัท เนโอนิกส์ จำกัด

Tel: 02-077-7602 หรือ 061-8268939

E-mail: sale@neonics.co.th หรือ sale@tools.in.th

# HI766 K-Type Thermocouple Probes with Handle



## HI766C, Penetration Probe

K-type thermocouple probe with sharp tip for penetration of semi-solid samples.

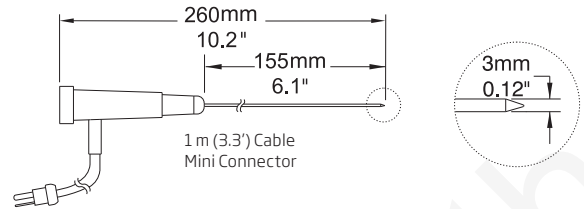

### Specifications

Code	Application	Max. Temperature	Response Time (90% of final value)	Probe Dimensions	Probe	Cable Color
HI766C	semi-solids, meat, rubber	900°C (1650°F)	15 seconds	L 155 mm x dia 3 mm (6.1 x 0.12")	stainless steel	green
HI766CL	semi-solids, meat, rubber	900°C (1650°F)	15 seconds	L 310 mm x dia 5 mm (12.2 x 0.19")	stainless steel	green



## HI766C1, Ultra-Fast Penetration Probe

Penetration probe with fast response time.

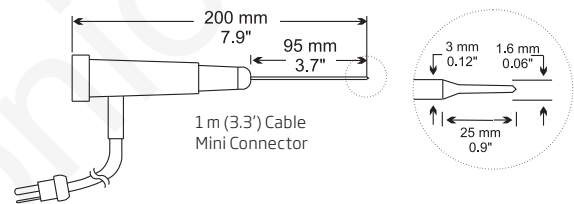

### Specifications

Code	Application	Max. Temperature	Response Time (90% of final value)	Probe Dimensions	Probe	Cable Color
HI766C1	semi-solids, food	300°C (570°F)	4 seconds	L 95 mm x dia 1.6 mm (3.7 x 0.06")	stainless steel	green



## HI766D Probe for Air and Gas

K-type thermocouple probe for measuring the temperature of air and gases.

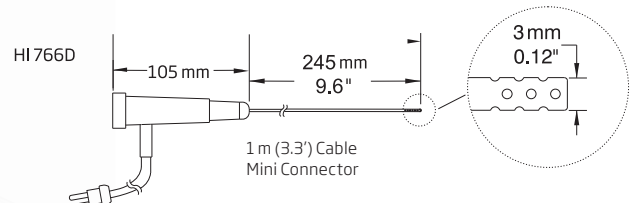

### Specifications

Code	Application	Max. Temperature	Response Time (90% of final value)	Probe Dimensions	Probe	Cable Color
HI766D	air, gases	300°C (570°F)	20 seconds	L 245 mm x dia 3 mm (9.6 x 0.12")	stainless steel	green

LINE ID:neonicstool



ติดต่อบริษัท เนโอเนคส์ จำกัด

Tel: 02-077-7602 หรือ 061-8268939

E-mail: sale@neonics.co.th หรือ sale@tools.in.th

# HI766 K-Type Thermocouple Probes with Handle

## HI766E1, General Purpose Probe

General purpose, penetration probe.

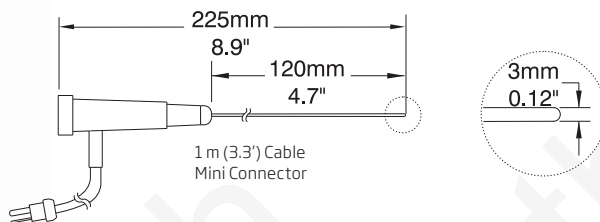

### Specifications

Code	Application	Max. Temperature	Response Time (90% of final value)	Probe Dimensions	Probe	Cable Length
HI766E1	liquids, air, gases	900°C (1650°F)	6 seconds	L 120 mm x dia 3 mm (4.7 x 0.12")	stainless steel	1 m (3.3')

## HI766E2, General Purpose Probe

General purpose, penetration probe.

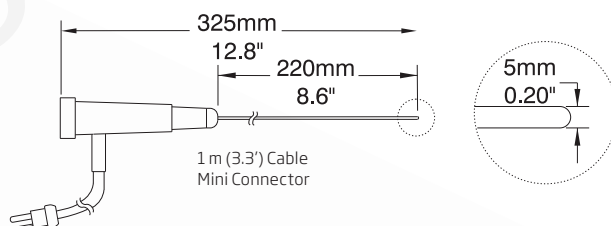
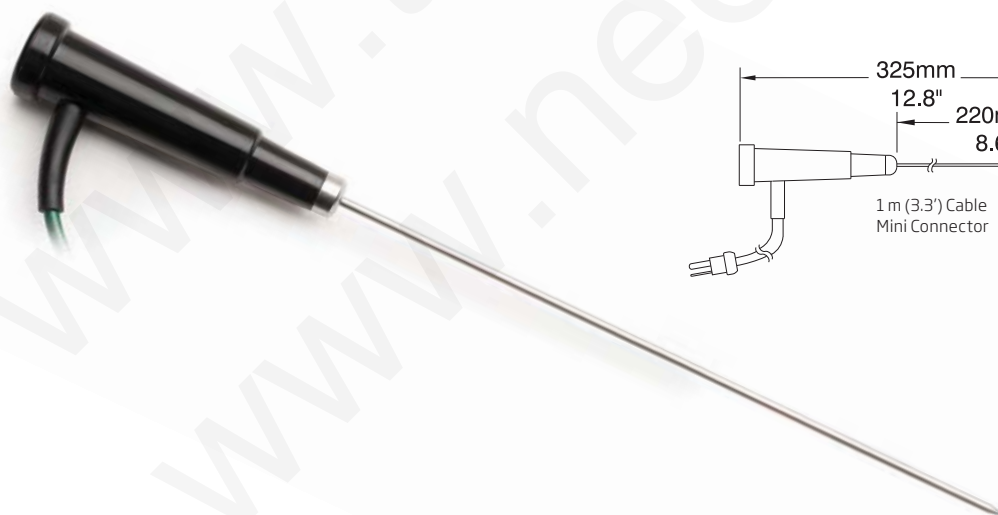

### Specifications

Code	Application	Max. Temperature	Response Time (90% of final value)	Probe Dimensions	Probe	Cable Length
HI766E2	liquids, air, gases	900°C (1650°F)	6 seconds	L 220 mm x dia 5 mm (8.5 x 0.2")	stainless steel	1 m (3.3')

LINE ID:neonicstool



ติดต่อบริษัท เนโอเนิกส์ จำกัด

Tel: 02-077-7602 หรือ 061-8268939

E-mail: sale@neonics.co.th หรือ sale@tools.in.th

# HI766 K-Type Thermocouple Surface Probes

## HI766A, Roller Surface Probe

This probe is designed to measure the temperature of convex surfaces.

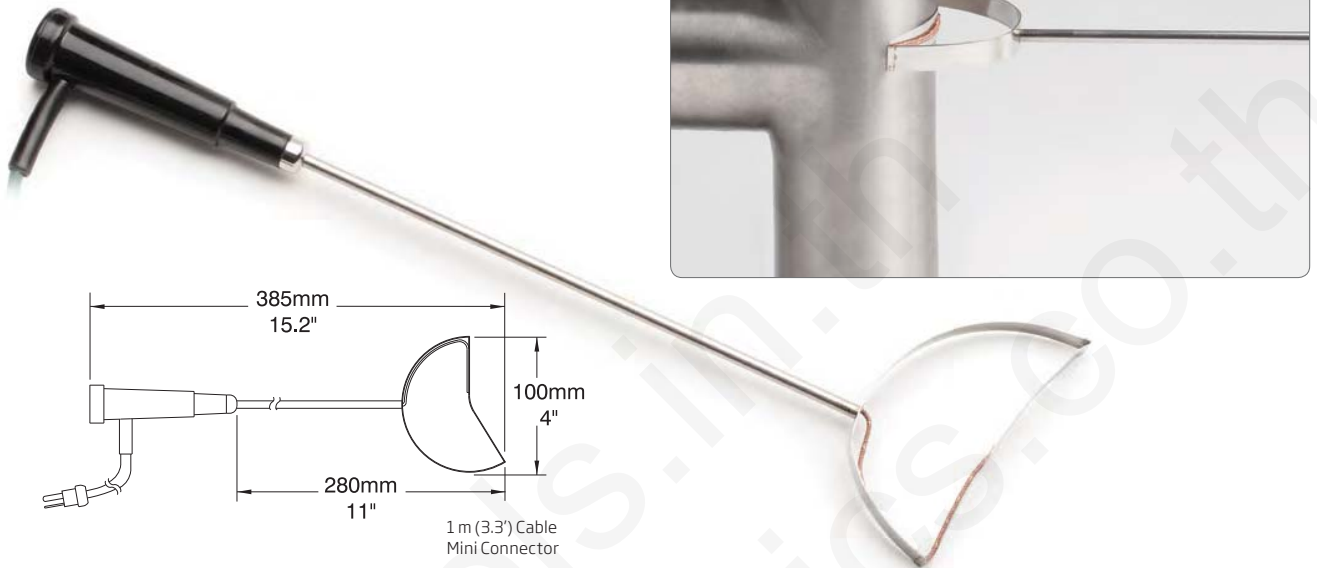

### Specifications

Code	Application	Max. Temperature	Response Time (90% of final value)	Probe Dimensions	Probe
HI766A	convex surfaces, moving rollers	320°C (600°F)	7 seconds	280 mm (11') (probe length)	stainless steel

## HI766B, Surface Probe

Temperature probe for measurements on surfaces.



### Specifications

Code	Application	Max. Temperature	Response Time (90% of final value)	Probe Dimensions	Probe
HI766B	hot solids, furnaces, molds	650°C (1200°F)	8 seconds	L 200 mm x dia 16 mm (7.9 x 0.6")	stainless steel

LINE ID:neonicstool



ติดต่อบริษัท เนโอเนิกส์ จำกัด

Tel: 02-077-7602 หรือ 061-8268939

E-mail: sale@neonics.co.th หรือ sale@tools.in.th

# HI766 K-Type Thermocouple Surface Probes



The following probes are designed to ensure optimal contact with surfaces of different shapes and dimensions.

When using these probes, the handle temperature must never exceed 150°C (302°F) to avoid possible damage to the probe.

## HI766B1, 90° Angle Surface Probe

Probe for measuring the temperature of 90° angle surfaces.

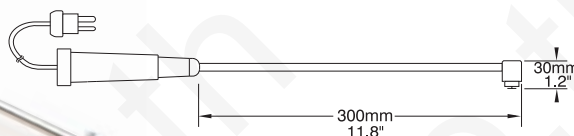

### Specifications

Code	Application	Max. Temperature	Response Time (90% of final value)	Probe Dimensions	Probe	Sensor
HI766B1	hard to reach surfaces	450°C (840°F)	8 seconds	L 300 mm x dia 30 mm (11.8 x 1.2")	stainless steel	spring-loaded



## HI766B2, Surface Probe

Probe for measuring the temperature of round surfaces.

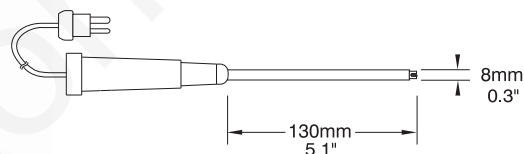

### Specifications

Code	Application	Max. Temperature	Response Time (90% of final value)	Probe Dimensions	Probe	Sensor
HI766B2	solids, furnaces, molds	900°C (1650°F)	3 seconds	L 130 mm x dia 8 mm (5.1 x 0.3")	stainless steel	spring-loaded



## HI766B3, Small Surface Probe

Probe for measuring the temperature of small surfaces.

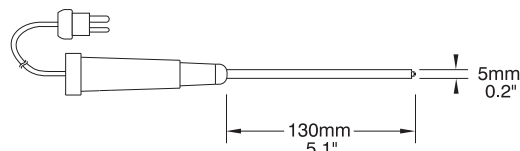

### Specifications

Code	Application	Max. Temperature	Response Time (90% of final value)	Probe Dimensions	Probe	Sensor
HI766B3	small surfaces	200°C (390°F)	6 seconds	L 130 mm x dia 5 mm (5.1 x 0.2")	stainless steel, insulated tube	spring-loaded

LINE ID:neonicstool



ติดต่อบริษัท เนอนิคส์ จำกัด

Tel: 02-077-7602 หรือ 061-8268939

E-mail: sale@neonics.co.th หรือ sale@tools.in.th



# HI766 K-Type Thermocouple Probes for Specific Applications

## HI766F, High Temperature Probe

Probe with flexible sheath without handle, designed to measure high temperatures.

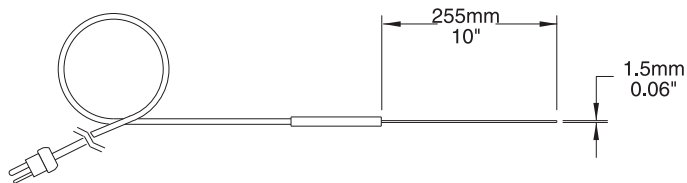

### Specifications

Code	Application	Max. Temperature	Response Time (90% of final value)	Probe Dimensions	Probe	Cable Length
<b>HI766F</b>	high temperature	1100°C (2000°F)	4 seconds	L 255 mm x dia 1.5 mm (10 x 0.06")	AISI 316 stainless steel	1 m (3.3')

## HI766F1, Wire Temperature Probe

Wire probe, designed to access hard to reach places. Probe does not incorporate a handle.

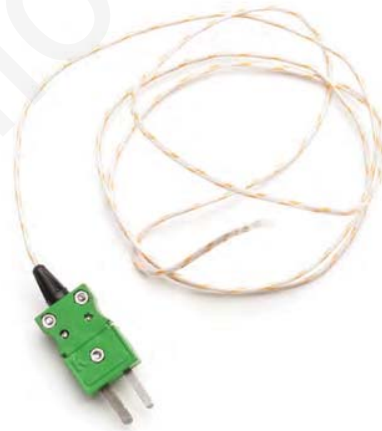
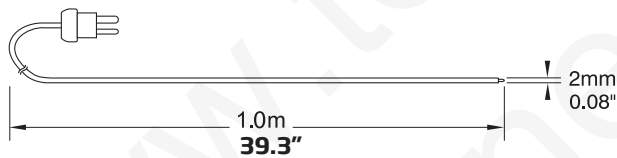

### Specifications

Code	Application	Max. Temperature	Response Time (63.2% F.S.)	Probe Dimensions	Sensor	Wire length
<b>HI766F1</b>	hard to reach areas	480°C (900°F)	1 second	dia 2 mm (0.08")	exposed wires	1 m (3.3')
<b>HI766F1/5</b>	hard to reach areas	480°C (900°F)	1 second	dia 2 mm (0.08")	exposed wires	5 m (16.4')

LINE ID:neonicstool



# HI766 K-Type Thermocouple Probes for Specific Applications

## HI766Z, Wire Temperature Probe

Wire probe, designed to measure temperature inside ovens.

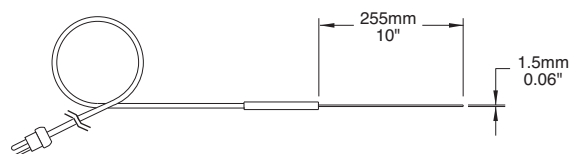

### Specifications

Code	Application	Max Temperature	Response Time (90% of final value)	Probe Dimensions	Sensor	Cable Length
HI766Z	ovens	1100°C (2000°F)	4 seconds	L 255 mm x dia 1.5 mm (10 x 0.06")	stainless steel	1.7 m (5.6')
HI766Z/3	ovens	1100°C (2000°F)	4 seconds	L 255 mm x dia 1.5 mm (10 x 0.06")	stainless steel	3 m (9.9')
HI766Z/7	ovens	1100°C (2000°F)	4 seconds	L 255 mm x dia 1.5 mm (10 x 0.06")	stainless steel	7 m (22.9')

## HI766TV1, Pipe Clamp Probe

Probe for measuring the temperature of pipes and tubes.



### Specifications

Code	Application	Max. Temperature	Response Time (90% of final Value)	Clamp Opening Diameter	Sensor
HI766TV1	pipes, tubes	200°C (390°F)	8 seconds	max 35 mm (1.4")	housed inside the clamp

LINE ID:neonicstool



ติดต่อบริษัท เนโอเนิกส์ จำกัด

Tel: 02-077-7602 หรือ 061-8268939

E-mail: sale@neonics.co.th หรือ sale@tools.in.th



# HI766 K-Type Thermocouple Probes for Specific Applications

## HI766TR1, Penetration Probe

K-type thermocouple probe with sharp tip for penetration of semi-solid samples.

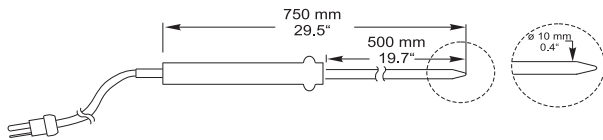

### Specifications

Code	Application	Max Temperature	Response Time (90% of final value)	Probe Dimensions	Sensor
<b>HI766TR1</b>	semi-solids, liquids	250°C (482°F)	10 seconds	L 500 mm x dia 10 mm (19.7 x 0.4")	stainless steel

## HI766TR2, HI766TR3, HI766TR4 Penetration Probes

K-type thermocouple probes with sharp tip for penetration of semi-solid samples.

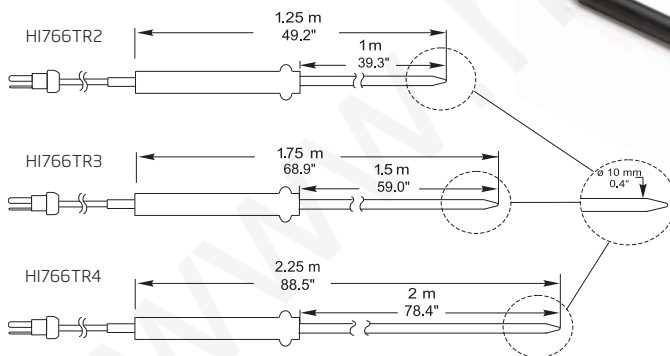

### Specifications

Code	Application	Max Temperature	Response Time (90% of final value)	Probe Length	Sensor
<b>HI766TR2</b>	semi-solids, liquids	250°C (482°F)	10 seconds	1 m (3.3')	stainless steel
<b>HI766TR3</b>	semi-solids, liquids	250°C (482°F)	10 seconds	1.5 m (5')	stainless steel
<b>HI766TR4</b>	semi-solids, liquids	250°C (482°F)	10 seconds	2 m (6.6')	stainless steel

LINE ID:neonicstool



ติดต่อบริษัท เน็ โอนิกส์ จำกัด

Tel: 02-077-7602 หรือ 061-8268939

E-mail: sale@neonics.co.th หรือ sale@tools.in.th