

Instruction Manual

HI 2400

Microprocessor Dissolved Oxygen Bench Meter

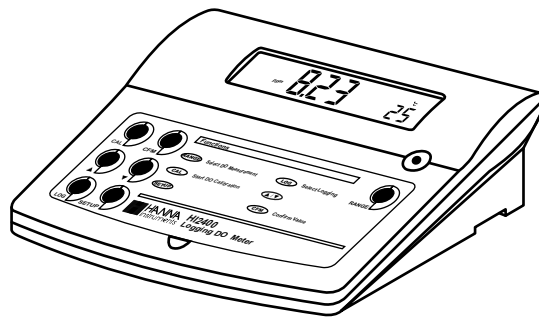

Dear Customer,
 Thank you for choosing a Hanna Instruments product.
 Please read this instruction manual carefully before using the instrument.
 This manual will provide you with the necessary information for correct use of the instrument, as well as a precise idea of its versatility.
 If you need additional technical information, do not hesitate to e-mail us at tech@hannainst.com or turn to the back cover for our worldwide contact list.
 This instrument is in compliance with **CE** directives.

WARRANTY

HI 2400 is guaranteed for two years against defects in workmanship and materials when used for their intended purpose and maintained according to instructions. The electrodes and the probes are guaranteed for a period of six months. This warranty is limited to repair or replacement free of charge. Damage due to accident, misuse, tampering or lack of prescribed maintenance are not covered.

If service is required, contact the dealer from whom you purchased the instrument. If under warranty, report the model number, date of purchase, serial number and the nature of the problem. If the repair is not covered by the warranty, you will be notified of the charges incurred. If the instrument is to be returned to Hanna Instruments, first obtain a Returned Goods Authorization number from the Technical Service department and then send it with shipping costs prepaid. When shipping any instrument, make sure it is properly packaged for complete protection.

TABLE OF CONTENTS

PRELIMINARY EXAMINATION	3
GENERAL DESCRIPTION.....	3
PROBE FUNCTIONAL DESCRIPTION	4
HI 2400 FUNCTIONAL DESCRIPTION	5
HI 2400 SPECIFICATIONS	6
OPERATIONAL GUIDE	7
D.O. CALIBRATION	10
TEMPERATURE CALIBRATION (for technical personnel only)	12
SETUP	13
LOGGING	18
PC INTERFACE	20
PROBE & MEMBRANE MAINTENANCE	25
ACCESSORIES	26

PRELIMINARY EXAMINATION

Remove the instrument from the packing material and examine it carefully to make sure that no damage has occurred during shipping. If there is any damage, notify your Dealer or the nearest Hanna Customer Service Center.

Each instrument is supplied with:

- HI 76407/2 D.O. probe with 2 m (6.7') cable
- HI 76407A membrane cap (2 pcs)
- HI 7041S electrolyte solution (30 ml)
- 12 VDC power adapter
- Instruction Manual

Note: Save all packing material until you are sure that the instrument functions correctly. All defective items must be returned in their original packing with the supplied accessories.

GENERAL DESCRIPTION

HI2400 is a logging microprocessor-based DO/Temperature bench meter.

It can store up to 99 lots in memory, with up to 8000 readings. These readings can be transferred to a computer for elaboration or permanent storage.

Dissolved Oxygen is indicated in ppm (parts per million) or in %.

All measurements are automatically compensated for temperature. Salinity compensation in water allows direct determination of Dissolved Oxygen in saline waters and altitude compensation readjusts for the altitude variance.

The Dissolved Oxygen probe has a membrane covering the polarographic sensors and a built-in thermistor for temperature measurements and compensation.

This permeable Teflon® membrane isolates the sensor elements from the testing solution, but allows Oxygen to pass through. When a voltage is applied across the sensor, oxygen that has passed through the membrane reacts causing a current flow, and hence determining a reading.

Teflon® is registered Trademark of "Du Pont de Nemours & Co."

PROBE FUNCTIONAL DESCRIPTION

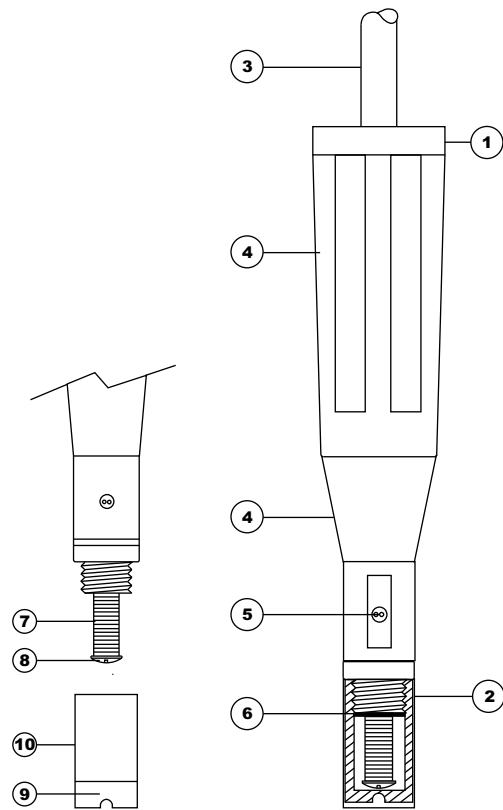

1. D.O. Probe
2. Protective Cap
3. Watertight Shielded Cable
4. Polypropylene Probe Body
5. Temperature Sensor
6. O-Ring Seal
7. Silver Chloride Anode
8. Platinum Cathode (sensor)
9. Oxygen Permeable Teflon® Membrane
10. Membrane Cap

HI 2400 FUNCTIONAL DESCRIPTION

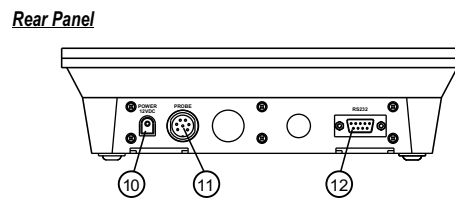
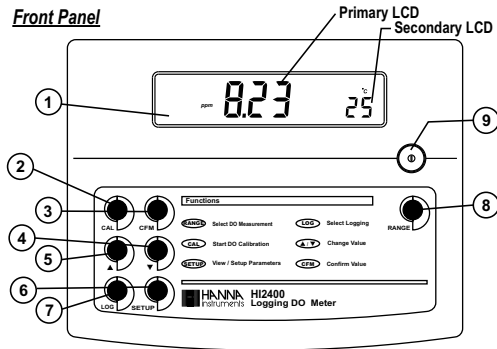

- 1) Liquid Crystal Display (LCD).
- 2) **CAL** key, to enter/exit calibration mode.
- 3) **CFM** key, to confirm different values.
- 4) ▼ key, to select the calibration value or to decrease other parameters.
- 5) ▲ key, to select the calibration value or to increase other parameters.
- 6) **SETUP** key, to enter/exit SETUP mode.
- 7) **LOG** key, to store measured data.
- 8) **RANGE** key, to select the measurement unit or to switch the focused data.
- 9) **ON/OFF** switch.
- 10) Power supply socket.
- 11) D.O. probe connector.
- 12) RS232 serial communication connector.

HI 2400 SPECIFICATIONS

RANGE	0.00 to 45.00 ppm
	0.0 to 300.0%
	0.0 to 50.0 °C
RESOLUTION	0.01 ppm
	0.1%
	0.1 °C
ACCURACY @ 20 °C/68 °F	±1.5% of full scale
	±0.5 °C
Typical EMC Deviation	±1.5% of full scale
	±0.5 °C
D.O. Calibration	Single or double point at 0% (HI 7040) and 100% (in air)
Altitude Compensation Resolution	0 to 4,000 m (13,120') 100 m (328')
Salinity Compensation Resolution	0 to 40 g/l 1 g/l
Temperature Compensation	0.0 to 50.0 °C (32 to 122 °F)
Probe	HI 76407/2 with 2 m (6.7') cable
Logging Interval	1, 15, 30 seconds or 1, 2, 5, 15, 30, 60, 120, 180 minutes
Computer Interface	opto-isolated RS232
Power supply	12 VDC adapter
Dimensions	240x182x74 mm (9.4x7.1x2.9")
Weight	1.1 Kg (2.5 lb)
Environment	0 – 50 °C (32 - 122 °F) max RH 95% non condensing
Warranty	2 years

OPERATIONAL GUIDE

POWER CONNECTION

Plug the 12 VDC adapter into the power supply socket.

Note: This instrument use non volatile memory to retain the calibration parameters and all the other settings even when unplugged.

Note: Make sure a fuse protects the main line.

PROBE CONNECTION AND PREPARATION

To take measurements, connect the D.O. probe to the meter securely by aligning the pins with the socket located on the back of the meter, pushing the plug in and tightening the threaded ring.

Probes shipped from Hanna Instruments are dry. To hydrate the probe and prepare it for use, connect it to the meter and proceed as follows:

1. Remove the red and black plastic cap.

This cap is for shipping purposes and can be thrown away.

2. Wet the sensor by soaking the bottom 2½ cm (1") of the probe in electrolyte (HI 7041S) for 5 minutes.

3. Rinse the membrane cap (HI 76407A supplied in the kit with the meter) with electrolyte solution while shaking it gently. Refill with clean electrolyte solution.

4. Tap gently the sides of the membrane cap with your finger tip to ensure that no air bubbles are trapped. To avoid damaging the membrane, do not tap it directly on the bottom.

5. Make sure that the rubber O-ring sits properly inside the membrane cap.

6. With the sensor facing down, slowly screw the cap clockwise. Some electrolyte will overflow.

When not in use and during polarization (see page 8), use the protective transparent cap supplied in the kit with the meter.

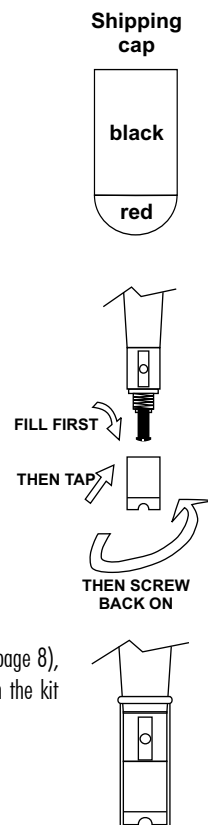

INSTRUMENT START-UP

- Turn the instrument on by pressing the **ON/OFF** switch.
- All LCD tags are displayed and a beep is generated while the instrument performs self test.



- After a few seconds "Cond" message appears on the LCD to inform the user that the probe is in auto-conditioning (automatic polarization) mode.



- When this message disappears, the probe is polarized and the instrument can be calibrated.
- If the probe is disconnected, the meter will display "----".

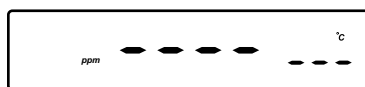

PROBE POLARIZATION

The probe is under polarization with a fixed voltage of approximately 800 mV. Probe polarization is essential for stable measurements with the same recurring degree of accuracy.

With the probe properly polarized, oxygen is continually consumed when it passes through the sensitive diaphragm and dissolves in the electrolyte solution contained in the probe.

If polarization is interrupted, the electrolyte solution continues to be enriched with oxygen until it reaches an equilibrium with the surrounding solution.

Whenever measurements are taken with a non-polarized probe, the oxygen level revealed is both that of the tested solution, as well as that present in the electrolyte solution. This reading is incorrect.

The calibration of this instrument is very simple.

Before proceeding with the calibration, make sure the probe is ready for measurements (see page 7), i.e. the membrane cap is filled with electrolyte and the probe is connected to the meter and properly polarized.

For an accurate calibration, it is recommended to wait at least 15 minutes to ensure precise conditioning of the probe.

Keep the protective cap on during polarization time and remove it for calibration and measurements. Follow the calibration procedure (see page 10).

SALINITY AND ALTITUDE COMPENSATION

If the sample contains significant concentration of salinity or if you are performing measurements at an altitude different from sea level, the read out values must be corrected, taking into account the lower degree of oxygen solubility in these situations (see pages 14-16).

Remember to set the altitude and/or the salinity before taking any D.O. measurements. The meter will automatically compensate for these factors.

D.O. MEASUREMENTS

Make sure that the instrument has been calibrated and the protective cap has been removed.

- Immerse the tip of the probe in the sample to be tested. Allow approximately one minute for the reading to stabilize.
- The Dissolved Oxygen value (in %) is displayed on the primary LCD and the temperature on the secondary LCD.

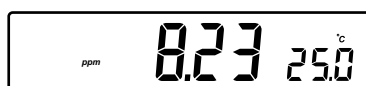

- Press **RANGE** to change the reading from % to ppm and vice-versa.

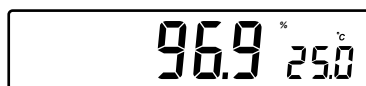

For accurate Dissolved Oxygen measurements, a water movement of 0.3 m/s is required. This is to ensure that the oxygen-depleted membrane surface is constantly replenished. A moving stream will provide adequate circulation. The use of a magnetic stirrer to ensure a certain fluid velocity is recommended.

TEMPERATURE MEASUREMENTS

The probe has a built-in temperature sensor.

The measured temperature is indicated on the secondary LCD as shown above. Allow the probe to reach thermal equilibrium before taking any measurement. This can take several minutes. The greater the difference between the temperature at which the probe was stored and the temperature of the sample, the longer the time will be.

Note: If "----" is displayed, the D.O. probe is not properly connected or the temperature is out of range. This also indicates the possibility of a broken probe cable.

D.O. CALIBRATION

Calibrate the instrument frequently, especially if high accuracy is required. The instrument can be calibrated in maximum 2 points: 0.0% (**zero calibration**) and 100.0% (**slope calibration**).

The zero calibration of the **HI 2400** is very stable, therefore this procedure needs to be performed only whenever the probe or the membrane is replaced. However, because the slope calibration is more critical, it is recommended to perform this procedure every week.

INITIAL PREPARATION

- Pour small quantities of HI 7040 Zero Oxygen solution into a beaker. If possible, use a plastic beaker to minimize any EMC interferences.
- Make sure the probe is ready for measurements (see probe preparation on page 7), i.e. the membrane is filled with electrolyte and the probe is connected to the meter.
- Switch the meter on by pressing the **ON/OFF** switch.
- For an accurate calibration, it is recommended to wait for at least 15 minutes to ensure precise conditioning of the probe.
- Remove the protective cap from the D.O. probe.
- Set the appropriate altitude factor (see page 14). Make sure the salinity factor is set to zero (see page 13).

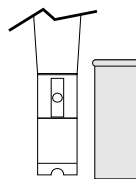

ZERO CALIBRATION

- Submerge the probe into HI 7040 zero oxygen solution and stir gently for 2-3 minutes.
- Press **CAL**. The “~” tag will blink on the LCD until the reading is stable.

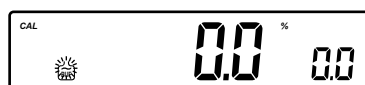

- When the reading is stable, “CFM” starts blinking. Press **CFM** to confirm the “0.0%” D.O. calibration.
- If the reading is within the limits ($\pm 15\%$ f.s.), the meter stores the value (and adjusts the slope point).



- Press **CAL**. The instrument will return to measurement mode and will memorize the zero calibration data. For a two-point calibration do not press **CAL** and follow the procedure below.



SLOPE CALIBRATION

It is suggested to perform the slope calibration in air.

- Rinse the probe in clean water to remove any residual zero oxygen solution.



Note: If you did not perform the zero calibration procedure, press **CAL** and then the **ARROW** keys to select the 100% D. O. calibration point.

- Dry the probe tip and allow a few seconds for the LCD reading to stabilize. The “~” tag will blink until the reading is stable.

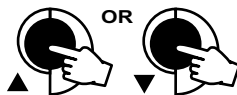

- When the reading is stable, “CFM” tag starts blinking. Press **CFM** to confirm the “100.0%” D.O. calibration.



- If the reading is within the limits ($\pm 15\%$ f.s.), the meter stores the value (and adjusts the slope point).
- The instrument stores the slope calibration data and returns to measurement mode.



Note: • If the reading is not close to the selected value, “WRONG” and “WRONG ↓” tags will blink alternatively.



- **HI 2400** has automatic buffer recognition function. If the **ARROW** keys are pressed to select the desired calibration value, the automatic buffer recognition function is disabled.

TEMPERATURE CALIBRATION (for technical personnel only)

Each meter has been factory calibrated for temperature with the supplied D.O. probe and is ready for measurements.

The D.O. probes are interchangeable and no temperature calibration is needed.

If the temperature measurements are not accurate, temperature recalibration should be performed.

For an accurate recalibration, contact your dealer or the nearest Hanna Customer Service Center, or follow the procedure below.

- Prepare a vessel containing ice and water and another one containing hot water (at a temperature of around 50 °C). Place insulation material around the vessels to minimize temperature changes.
- Use a **ChecktempC** or a calibrated thermometer with a resolution of 0.1 °C as a reference thermometer. Connect the **HI 76407/2** D.O. probe to the appropriate socket.
- With the instrument off, press and hold down **CAL**, then power on the instrument. The "CAL" tag will appear and the secondary LCD will show 0.0 °C.



- Immerse the D.O. probe in the vessel with ice and water as near as possible to the **ChecktempC**. Allow a few seconds for the probe to stabilize.

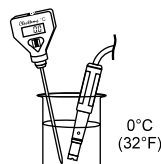

- Use the "▲" or "▼" key to set the reading on the secondary LCD to that of ice and water, measured by **ChecktempC**. When the reading is stable, "CFM" tag starts blinking.
- Press **CFM** to confirm. The secondary LCD will show 50.0 °C.

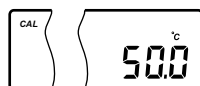

- Immerse the D.O. probe in the second vessel as near as possible to the **ChecktempC**. Allow a few seconds for the probe to stabilize.
- Use the "▲" or "▼" key to set the reading on the secondary LCD to that of the hot water.
- When the reading is stable, "CFM" tag starts blinking.
- Press **CFM** to confirm. The instrument returns to measurement mode.

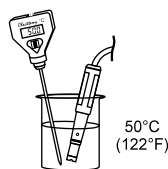

Note: If the reading is not close to the selected calibration point, "WRONG" tag will blink. In this case, check if the value set on the secondary LCD and the temperature measured with **ChecktempC** are close. Change the D.O. probe or restart calibration if necessary.

SETUP

Setup mode allows viewing and modifying the following parameters:

- Salinity Compensation
- Altitude Compensation
- Log Interval
- Time
- Date
- Baud Rate
- Command Prefix
- Beep Status

To enter the Setup mode press **SETUP** while the instrument is in measurement mode. Press **SETUP** again to exit SETUP mode.

Select a parameter with the **ARROW** keys.

Press **CAL** if you want to change a parameter value. The selected parameter will blink.

Press the **ARROW** keys to increase or decrease the displayed value.

Press **CFM** to save the modified value or **CAL** to escape.

Press the **ARROW** keys to select the next/previous parameter.

SALINITY COMPENSATION SET

Press **CAL** when the salinity factor is displayed. The salinity factor (0 to 40 g/l) will start blinking.



Press **ARROW** keys to change the salinity factor value.

Press **CFM** to save the modified value or press **CAL** to escape without saving.

The salinity affects the D.O. concentration, decreasing its value. The table below shows the maximum oxygen solubility at various temperatures and salinity levels.

°C	Salinity (g/l) at Sea Level					°F
	0 g/l	10 g/l	20 g/l	30 g/l	35 g/l	
0	14.60	13.64	12.74	11.90	11.50	32.0
2	13.81	12.91	12.07	11.29	10.91	36.5
4	13.09	12.25	11.47	10.73	10.38	39.2
6	12.44	11.65	10.91	10.22	9.89	42.8
8	11.83	11.09	10.40	9.75	9.44	46.4
10	11.28	10.58	9.93	9.32	9.03	50.0
12	10.77	10.11	9.50	8.92	8.65	53.6
14	10.29	9.68	9.10	8.55	8.30	57.2
16	9.86	9.28	8.73	8.21	7.97	60.8
18	9.45	8.90	8.39	7.90	7.66	64.4
20	9.08	8.56	8.07	7.60	7.38	68.0
22	8.73	8.23	7.77	7.33	7.12	71.6
24	8.40	7.93	7.49	7.07	6.87	75.2
25	8.24	7.79	7.36	6.95	6.75	77.0
26	8.09	7.65	7.23	6.83	6.64	78.8
28	7.81	7.38	6.98	6.61	6.42	82.4
30	7.54	7.14	6.75	6.39	6.22	86.0
32	7.29	6.90	6.54	6.19	6.03	89.6
34	7.05	6.68	6.33	6.01	5.85	93.2
36	6.82	6.47	6.14	5.83	5.68	96.8
38	6.61	6.28	5.96	5.66	5.51	100.4
40	6.41	6.09	5.79	5.50	5.36	104.0
42	6.22	5.93	5.63	5.35	5.22	107.6
44	6.04	5.77	5.48	5.21	5.09	111.2
46	5.87	5.61	5.33	5.07	4.97	114.8
48	5.70	5.47	5.20	4.95	4.85	118.4
50	5.54	5.33	5.07	4.83	4.75	122.0

Note: The relationship between salinity and chlorinity for sea water is given by the equation below:

$$\text{Salinity (g/l)} = 1.80655 \text{ Chlorinity (g/l)}$$

ALTITUDE COMPENSATION SET

Press **CAL** when the altitude factor is displayed. The altitude factor (0 to 4000 m, in steps of 100 m; 1 meter = 3.28 feet) will start blinking.

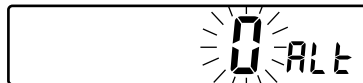

Press the **ARROW** keys to change the altitude factor value.

Press **CFM** to save the modified value or press **CAL** to escape without saving.

°C	Altitude, Meters above Sea Level															°F
	0 m	300 m	600 m	900 m	1200 m	1500 m	1800 m	2100 m	2400 m	2700 m	3000 m	3300 m	3600 m	3900 m	4000 m	
0	14.6	14.1	13.6	13.1	12.6	12.1	11.7	11.2	10.8	10.4	10.0	9.7	9.3	9.0	8.9	32.0
2	13.8	13.3	12.8	12.4	11.9	11.5	11.0	10.6	10.2	9.9	9.5	9.2	8.8	8.5	8.4	35.6
4	13.1	12.6	12.2	11.7	11.3	10.9	10.5	10.1	9.7	9.3	9.0	8.7	8.4	8.0	7.9	39.2
6	12.4	12.0	11.5	11.1	10.7	10.3	9.9	9.6	9.2	8.9	8.6	8.2	7.9	7.6	7.5	42.8
8	11.8	11.4	11.0	10.6	10.2	9.8	9.5	9.1	8.8	8.4	8.1	7.8	7.5	7.3	7.2	46.4
10	11.3	10.9	10.5	10.1	9.7	9.4	9.0	8.7	8.4	8.1	7.8	7.5	7.2	6.9	6.8	50.0
12	10.8	10.4	10.0	9.6	9.3	8.9	8.6	8.3	8.0	7.7	7.4	7.1	6.9	6.6	6.5	53.6
14	10.3	9.9	9.6	9.2	8.9	8.5	8.2	7.9	7.6	7.4	7.1	6.8	6.6	6.3	6.2	57.2
16	9.9	9.5	9.2	8.8	8.5	8.2	7.9	7.6	7.3	7.0	6.8	6.5	6.3	6.1	6.0	60.8
18	9.5	9.1	8.8	8.5	8.1	7.8	7.6	7.3	7.0	6.8	6.5	6.3	6.0	5.8	5.7	64.4
20	9.1	8.8	8.4	8.1	7.8	7.5	7.3	7.0	6.7	6.5	6.2	6.0	5.8	5.6	5.5	68.0
22	8.7	8.4	8.1	7.8	7.5	7.2	7.0	6.7	6.5	6.2	6.0	5.8	5.6	5.4	5.3	71.6
24	8.4	8.1	7.8	7.5	7.2	7.0	6.7	6.5	6.2	6.0	5.8	5.6	5.4	5.2	5.1	75.2
25	8.3	8.0	7.7	7.4	7.1	6.8	6.6	6.4	6.1	5.9	5.7	5.5	5.3	5.1	5.0	77.0
26	8.1	7.8	7.5	7.2	7.0	6.7	6.5	6.2	6.0	5.8	5.6	5.4	5.2	5.0	4.9	78.8
28	7.8	7.5	7.3	7.0	6.7	6.5	6.2	6.0	5.8	5.6	5.4	5.2	5.0	4.8	4.7	82.4
30	7.6	7.3	7.0	6.8	6.5	6.3	6.0	5.8	5.6	5.4	5.2	5.0	4.8	4.6	4.6	86.0
32	7.3	7.0	6.8	6.5	6.3	6.1	5.8	5.6	5.4	5.2	5.0	4.8	4.7	4.5	4.4	89.6
34	7.1	6.8	6.6	6.3	6.1	5.9	5.6	5.4	5.2	5.0	4.9	4.7	4.5	4.3	4.3	93.2
36	6.8	6.6	6.3	6.1	5.9	5.7	5.5	5.3	5.1	4.9	4.7	4.5	4.4	4.2	4.1	96.8
38	6.6	6.4	6.1	5.9	5.7	5.5	5.3	5.1	4.9	4.7	4.5	4.4	4.2	4.1	4.0	100.4
40	6.4	6.2	5.9	5.7	5.5	5.3	5.1	4.9	4.7	4.6	4.4	4.2	4.1	3.9	3.9	104.4
42	6.2	6.0	5.8	5.6	5.3	5.2	5.0	4.8	4.6	4.4	4.3	4.1	4.0	3.8	3.8	107.6
44	6.0	5.8	5.6	5.4	5.2	5.0	4.8	4.6	4.5	4.3	4.1	4.0	3.8	3.7	3.7	111.2
46	5.8	5.6	5.4	5.2	5.0	4.8	4.7	4.5	4.3	4.2	4.0	3.9	3.7	3.6	3.5	114.8
48	5.7	5.5	5.3	5.1	4.9	4.7	4.5	4.4	4.2	4.0	3.9	3.7	3.6	3.5	3.4	118.4
50	5.5	5.3	5.1	4.9	4.7	4.6	4.4	4.2	4.1	3.9	3.8	3.6	3.5	3.4	3.3	122.0

The altitude affects D.O. concentration, decreasing its value. The table on the previous page reports the maximum oxygen solubility at various temperatures and altitudes.

LOGGING INTERVAL SET

Press **CAL** when the logging interval is displayed. The logging interval (1, 15, 30 s, or 1, 2, 5, 15, 30, 60, 120, 180 min) will start blinking.

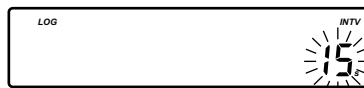

Press the **ARROW** keys to change the logging interval value.
Press **CFM** to save the modified value or press **CAL** to escape without saving.

CURRENT TIME SET

Press **CAL** when the current time is displayed. The hour will start blinking.



Press the **ARROW** keys to change the displayed value.
Press **RANGE**. The minutes will start blinking.



Press the **ARROW** keys to change the displayed value.
Press **CFM** to save the modified value or press **CAL** to escape without saving.

CURRENT DATE SET

Press **CAL** when the current date is displayed. The month will start blinking.



Press the **ARROW** keys to change the month.

Press **RANGE**. The day will start blinking.



Press the **ARROW** keys to change the displayed value.

Press **RANGE**. The year will start blinking on the secondary LCD.



Press the **ARROW** keys to change the year.

Press **CFM** to save the modified value or press **CAL** to escape without saving.

SERIAL COMMUNICATION BAUD RATE SET

Press **CAL** when the baud rate is displayed. The baud rate (150, 300, 600, 1200, 2400, 4800 or 9600) will start blinking.



Press the **ARROW** keys to change the baud rate.

Press **CFM** to save the modified value or press **CAL** to escape without saving.

SERIAL COMMUNICATION COMMAND PREFIX SET

Press **CAL** when the command prefix is displayed. The command prefix (0 to 48) will start blinking.



Press the **ARROW** keys to change the command prefix.

Press **CFM** to save the modified value or press **CAL** to escape without saving.

Note: • See the PC interface section on page 39 for a complete explanation.

- The command prefix must be 16 if **HI 92000** PC software is used.

BEEP STATUS SET

Press **CAL** when the beep status is displayed. The beep status (ON or OFF) will start blinking.



Press the **ARROW** keys to change the beep status.

Press **CFM** to save the modified value or press **CAL** to escape without saving.

LOGGING

This function allows the user to log D.O. (in ppm or %) together with temperature automatically, for long periods of time. All logged data can be stored into a PC through the RS232 port.

The memory used for storing the logged data is divided in 16 pages. The capacity of each page is 500 samples. The lot number goes from 1 to 99. The maximum capacity of the log memory is 8000 samples. Each time a new lot starts, it automatically starts from a new page. When the samples collected for a single lot reach the limit (8000 samples) or all memory pages are occupied, the meter stops logging automatically.

The appropriate logging interval can be set between 1, 15, 30 seconds or 1, 5, 30, 60, 120, 180 minutes (see SETUP section for details).

LOGGING THE CURRENT DATA

To start the Auto LOG mode press **LOG** while in measurement mode.

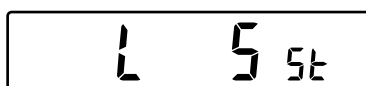

The instrument will display for about five seconds the lot number on the primary LCD and start message ("St") on the secondary LCD.

The instrument starts data logging and displays the current D.O. value on the primary LCD and the temperature on the secondary LCD line, along with the "LOG" tag.



To stop the Auto LOG mode press **LOG** again. The instrument will display for about five seconds the sample number on the primary LCD and the lot number on the secondary LCD.



The instrument returns to normal measurement mode. If the log space is full, the "FULL" message will be displayed and no more data will be saved.

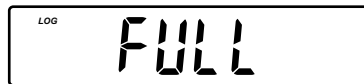

- Note:**
- Pressing **RANGE** during the logging mode, the instrument toggles between measurement reading (in ppm and %) and sample number on the primary LCD, together with lot number on the secondary LCD.
 - While in Auto LOG mode, **CAL** & **SETUP** keys are inactive.

TO DELETE LOTS

Press **CFM** to enter deleting mode. If no data were logged, the instrument displays:



Otherwise, it will display the "dEL" message on the primary LCD and the selected lot number on the secondary LCD. The "CFM" tag will blink.



Press the **ARROW** keys to change the lot number or press **SETUP** to select the current lot number or all memorized lots to be deleted.

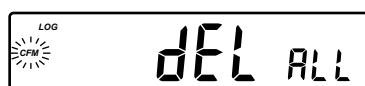

Press **CFM** to confirm deletion of the selected lot or of all memorized lots.

Note:

- After all records are deleted, the instrument displays "FrEE ALL message for a few seconds and returns to measurement mode.

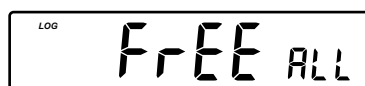

- Press **CAL** to exit and return to normal measurement mode at any time.

PC INTERFACE

Data transmission from the instrument to the PC can be done with the **HI 92000** Windows[®] compatible software (optional). **HI 92000** also offers graphing and on-line help feature.

Data can be exported to the most popular spreadsheet programs for further analysis.

To connect your instrument to a PC, use the optional Hanna **HI 920010** cable connector. Make sure that your instrument is switched off and plug one connector to the instrument RS232C socket and the other to the serial port of your PC.

Note:

- Other cables than **HI 920010** may use a different configuration. In this case communication between instrument and PC may not be possible.
- If you are not using Hanna Instruments **HI 92000** software, please see the following instructions.

SENDING COMMANDS FROM PC

It is also possible to remotely control the instrument with any terminal program. Use **HI 920010** cable to connect the instrument to a PC, start the terminal program and set the communication options as follows: 8, N, 1, no flow control.

COMMAND TYPES

To send a command to the D.O. meter the scheme is:

<DLE> <command><CR>

This line makes the computer send a Data Link Escape character, the command expressed as a number or a 3-character sequence and a CR character.

Note: All terminal programs that support the ANSI escape sequence, represent the DLE character by the string '^P' and the CR character by the string '^M'. E.g. the line '^PPM^M' sets the range to ppm.

Commands not requiring an answer from the meter:

PPM sets the range to ppm D.O.

PER sets the range to % D.O.

Note: If not in measurement, calibration or LOG mode, "Err 8" is sent.

Commands requiring an answer:

DO? Causes the meter to send the D.O. (% or ppm will depend on the meter setting). If the reading is out of range, "Err 1" is sent.

TM? Causes the meter to send the temperature value. If the reading is out of range, "Err 3" is sent.

Note: If not in measurement, calibration or LOG mode, "Err 8" is sent.

DA? Requests the meter to send the date.

E.g. "022896" for 28th Feb. 96

TI? Requests the meter to send the time.

E.g.

"233001" for 23:30 hr, 1 sec. as interval

"233002" for 23:30 hr, 15 sec. as interval

"233003" for 23:30 hr, 30 sec. as interval

"233004" for 23:30 hr, 1 min. as interval

"233005" for 23:30 hr, 5 min. as interval

"233006" for 23:30 hr, 30 min. as interval

"233007" for 23:30 hr, 60 min. as interval

"233008" for 23:30 hr, 120 min. as interval

"233009" for 23:30 hr, 180 min. as interval

?ML Requests the meter to send the available lot number collected in memory. The transmission begins with <STX> and terminates with <ETX>. The data are sent in the following order:

1) stx

2) Lot number

E.g. "01" for lot No. 1

3) Total number of samples per lot

E.g. "1234" for total no. of samples: 1234.

- 4) Channel #1 status
E.g. "1" for ppm logging selected in this lot
"0" for ppm logging not selected in this lot
- 5) Channel #2 status
E.g. "1" for % logging selected in this lot
"0" for % logging not selected in this lot
- 6) Channel #3 status
E.g. "1" for not used "0" for not used
- 7) Channel #4 status
E.g. "1" for temperature logging selected in this lot
"0" for temperature logging not selected in this lot
- 8) ... Repeat from 2 to 7 for the next available lot No.
- 9) etc

?VM Requests the meter to send the selected lot status. The data is sent in the following order:

- 1) stx
- 2) Lot number E.g. "01" for lot No. 1
- 3) Total number of samples per lot
E.g. "1234" for total no. of samples: 1234.
- 4) Channel #1 status
E.g. "1" for ppm logging selected in this lot
"0" for ppm logging not selected in this lot
- 5) Channel #2 status
E.g. "1" for % logging selected in this lot
"0" for % logging not selected in this lot
- 6) Channel #3 status
E.g. "1" for not used "0" for not used
- 7) Channel #4 status
E.g. "1" for temperature logging selected in this lot
"0" for temperature logging not selected in this lot
- 8) Begin sample time, min. E.g. "59" for 59 minutes
- 9) Begin sample time, hour. E.g. "12" for 12 hours
- 10) Begin sample time, day. E.g. "09" for the 9th day
- 11) Begin sample time, month. E.g. "09" for September
- 12) Begin sample time, year. E.g. "96" for year 1996
- 13) Logging interval. E.g. "0" for 1 second
"1" for 15 seconds
"2" for 30 seconds

"3" for 1 minute
"4" for 5 minutes
"5" for 30 minutes
"6" for 60 minutes
"7" for 120 minutes
"8" for 180 minutes

- 14) last sample time, min. E.g. "59" for 59 minute
- 15) last sample time, hour. E.g. "12" for 12 hour
- 16) last sample time, day. E.g. "09" for 9th day
- 17) last sample time, month. E.g. "09" for September
- 18) last sample time, year. E.g. "96" for year 1996
- 19) etx end

?DM Requests the meter to send the selected lot data memory. The data is sent in the following order:

- 1) stx
- 2) Lot number E.g. "01" for lot No. 1

Note: From 3) to 12) steps see the 4) to 13) steps of "**?VM**" command.

- 13) Total number of samples per lot
E.g. "1234" for total no. of samples: 1234.
- 14) Logged data in signed integer, repeat sending in logged channel sequence
sample no. 1
—— send ppm data if ppm is log selected
—— send % data if % is log selected
—— send temperature data if temperature is log selected
sample no. 2 ...
until the last sample
sample "XXX" is signed hex format.
- 15) last sample time, min. E.g. "59" for 59 minute
- 16) last sample time, hour. E.g. "12" for 12 hour
- 17) last sample time, day. E.g. "09" for 9th day
- 18) last sample time, month. E.g. "09" for September
- 19) last sample time, year. E.g. "96" for year 1996
- 20) etx end

Commands setting parameters:

/ML To select the data lot for data transfer.

E.g. send "/MLO5" to select lot no. 5.
If the lot no. is valid, the meter will send <ACK>, otherwise it will send <CAN>.

/BR To set the RS232C baud rate.
E.g. send "/BR0" to set the meter to baud rate of 150
send "/BR1" to set the meter to baud rate of 300
send "/BR2" to set the meter to baud rate of 600
send "/BR3" to set the meter to baud rate of 1200
send "/BR4" to set the meter to baud rate of 2400
send "/BR5" to set the meter to baud rate of 4800
send "/BR6" to set the meter to baud rate of 9600

/PF To set the RS232C command prefix.
E.g. send "/PF05" to set the command prefix to 05.

Note: <ACK> will be sent by the meter if the command received is accepted, otherwise it will send <CAN>.

<ACK> equals to ASCII code 06 and <CAN> equals to ASCII code 24.

If sample data is out of range "07FFFH" is sent.

These commands may be sent with either capital or small letters. Invalid commands will be ignored. The characters sent by the pH meter are always capital letters.

PROBE & MEMBRANE MAINTENANCE

The oxygen probe body is made of reinforced plastic for maximum durability. A thermistor temperature sensor provides temperature measurements of the sample. Use the protective probe cap when not in use.

To replace the membrane or refill with electrolyte, proceed as follows:

- Remove the protective cap by gently twisting and pulling it off the body of the probe (see fig. 1).
- Unscrew the membrane cap by turning it counterclockwise (see fig.2).
- Wet the sensor by soaking the bottom 2½ cm (1") of the probe in electrolyte (HI 7041S) for 5 minutes.
- Rinse the new membrane cap (HI 76407A), supplied with the meter with electrolyte solution while shaking it gently. Refill with clean electrolyte solution.
- Gently tap the sides of the membrane cap with your finger tip to ensure that no air bubbles remain trapped. Do not tap directly the bottom with your finger, as this will damage the membrane.
- Make sure that the rubber O-ring sits properly inside the membrane cap.
- With the sensor facing down, slowly screw the membrane cap clockwise. Some electrolyte will overflow.

The Platinum cathode (#8 in the Functional Description page 4) should always be bright and untarnished. If it is tarnished or stained, the cathode should be cleaned. You can use a clean lint-free cardboard or cloth. Rub the cathode very gently side to side 4-5 times. This will be enough to polish and remove any stains without damaging the platinum tip. Afterwards, rinse the probe with deionized or distilled water and install a new membrane cap using fresh electrolyte and follow the steps above. Recalibrate the instrument.

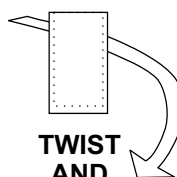

**TWIST
AND
PULL**

fig. 1

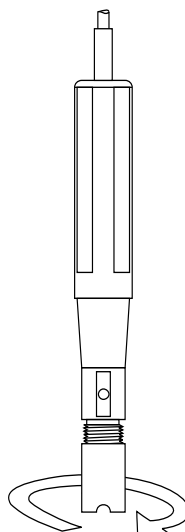

UNSCREW

fig. 2

Important

In order to have accurate and stable measurements, it is important that the membrane surface is in perfect condition. This semipermeable membrane isolates the sensor elements from the environment but allows oxygen to enter. If any dirt is observed on the membrane, rinse carefully with distilled or deionized water. If any imperfections still exist, or any damage is evident (such as wrinkles or tears-holes), the membrane should be replaced. Make sure that the O-Ring sits properly in the membrane cap.

ACCESSORIES

ChecktempC	Electronic thermometer (range: -50.0 to 150.0 °C)
ChecktempF	Electronic thermometer (range: -58.0 to 302 °F)
HI 7040M	Zero Oxygen Solution, 230 ml
HI 7040L	Zero Oxygen Solution, 460 ml
HI 7041S	Refilling Electrolyte Solution, 30 ml
HI 710005	115VAC to 12VDC converter
HI 710006	230VAC to 12VDC converter
HI 76407/2	Spare probe with 2 meters (6.7') cable
HI 76407/10	Spare probe with 10 meters (33') cable
HI 76407/20	Spare probe with 20 meters (67') cable
HI 76407A/P	5 spare membranes
HI 92000	Windows® compatible software application
HI 920010	25-pin PC connection cable
HI 920010/9	9-pin PC connection cable

Windows® is registered Trademark of "Microsoft Co."

RECOMMENDATIONS FOR USERS

Before using this product, make sure that it is entirely suitable for the environment in which it is used.

Operation of this instrument in residential areas could cause unacceptable interferences to radio and TV equipment, requiring the operator to take all necessary steps to correct interferences.

To maintain the EMC performance of this equipment, the recommended cables must be used. Any variation introduced by the user to the supplied equipment may degrade the instrument's EMC performance.

To avoid electrical shock, do not use this instrument when voltages at the measurement surface exceed 24 VAC or 60 VDC.

To avoid damage or burns, do not perform any measurements in microwave ovens.

Hanna Instruments reserves the right to modify the design, construction and appearance of its products without advance notice.

SALES AND TECHNICAL SERVICE CONTACTS

Australia:

Tel. (03) 9769.0666 • Fax (03) 9769.0699

China:

Tel. (10) 88570068 • Fax (10) 88570060

Egypt:

Tel. & Fax (02) 2758.683

Germany:

Tel. (07851) 9129-0 • Fax (07851) 9129-99

Greece:

Tel. (210) 823.5192 • Fax (210) 884.0210

Indonesia:

Tel. (21) 4584.2941 • Fax (21) 4584.2942

Japan:

Tel. (03) 3258.9565 • Fax (03) 3258.9567

Korea:

Tel. (02) 2278.5147 • Fax (02) 2264.1729

Malaysia:

Tel. (603) 5638.9940 • Fax (603) 5638.9829

Singapore:

Tel. 6296.7118 • Fax 6291.6906

South Africa:

Tel. (011) 615.6076 • Fax (011) 615.8582

Taiwan:

Tel. 886.2.2739.3014 • Fax 886.2.2739.2983

Thailand:

Tel. 66.2619.0708 • Fax 66.2619.0061

United Kingdom:

Tel. (01525) 850.855 • Fax (01525) 853.668

USA:

Tel. (401) 765.7500 • Fax (401) 765.7575

For e-mail contacts and a complete list of Sales and Technical offices, please see www.hannainst.com.

MAN2400
05/05