

L2001 L2001-01 PINCHER PROBE

Instruction Manual

Dec. 2015 Revised edition 1
Printed in Japan
L2001A981-01 15-12H

EN



HIOKI E. E. CORPORATION

Test Equipment Depot
99 Washington Street
Melrose, MA 02176
Phone 781-665-1400
1-800-517-8431 Toll Free 1-800-517-8431

Visit us at www.TestEquipmentDepot.com

Warranty

Warranty malfunctions occurring under conditions of normal use in conformity with the Instruction Manual and Product Precautionary Markings will be repaired free of charge. This warranty is valid for a period of one (1) year from the date of purchase. Please contact the distributor from which you purchased the product for further information on warranty provisions.

Introduction

Thank you for purchasing the HIOKI L2001 and L2001-01 Pincher Probe. To obtain maximum performance from the device, please read this manual first, and keep it handy for future reference.

Verifying Package Contents

When you receive the device, inspect it carefully to ensure that no damage occurred during shipping. In particular, check the accessories and connectors. If damage is evident, or if it fails to operate according to the specifications, contact your authorized Hioki distributor or reseller.

Cleaning

To clean the device, wipe it gently with a soft cloth moistened with water or mild detergent.

IMPORTANT Never use solvents such as benzene, alcohol, acetone, ether, ketones, thinners or gasoline, as they can deform and discolor the case.

Repair

If the device seems to be malfunctioning, contact your authorized Hioki distributor or reseller.

Disposal

Handle and dispose of the instrument in accordance with local regulations.

Safety Notes

Before using the instrument, be certain to carefully read the following safety notes.

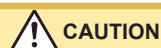

- Mishandling during use could damage to the device. Be certain that you understand the instructions and precautions in the manual before use.
- If persons unfamiliar with electricity measuring device are to use the device, another person familiar with such instruments must supervise operations.

Notation

In this manual, the risk seriousness and the hazard levels are classified as follows.

	WARNING	Indicates a potentially hazardous situation that may result in death or serious injury to the operator.
	CAUTION	Indicates a potentially hazardous situation that may result in minor or moderate injury to the operator or damage to the device or malfunction.
	IMPORTANT	Indicates information related to the operation of the device or maintenance tasks with which the operators must be fully familiar.
		Indicates cautions and hazards. When the symbol is printed on the device, refer to a corresponding topic in the Instruction Manual.
		Indicates prohibited actions.
		Indicates the action which must be performed.

Symbols for various standards

	This symbol indicates that the product conforms to regulations set out by the EC Directive.
	WEEE marking: This symbol indicates that the electrical and electronic appliance is put on the EU market after August 13, 2005, and producers of the Member States are required to display it on the appliance under Article 11.2 of Directive 2002/96/EC (WEEE).

Usage Notes

Follow these precautions to ensure safe operation and to obtain the full benefits of the various functions



- Installing the instrument in inappropriate locations may cause a malfunction of instrument or may give rise to an accident. Avoid the following locations.
- Exposed to direct sunlight or high temperature
 - Exposed to corrosive or combustible gases
 - Exposed to water, oil, chemicals, or solvents
 - Exposed to high humidity or condensation
 - Exposed to a strong electromagnetic field or electrostatic charge
 - Exposed to high quantities of dust particles
 - Near induction heating systems (such as high-frequency induction heating systems and IH cooking equipment)
 - Subject to vibration

Precautions during shipment

Use the original packing materials when transporting the device, if possible. Pack the device so that it will not sustain damage during shipping, and include a description of existing damage. We do not take any responsibility for damage incurred during shipping.

Overview

The L2001 and L2001-01 Pincher Probe is a pincher-type probe that can be connected directly to measurement terminals (labeled "UNKNOWN") on Hioki LCR meters, impedance analyzers, and Capacitance HiTesters. Among the targets it can measure are chip components. Each of the arm tips features a two-terminal design. * The L2001 and L2001-01 provide different characteristic impedance from each other. Please connect a model specified to be compatible with an instrument to be operated.

Parts Names

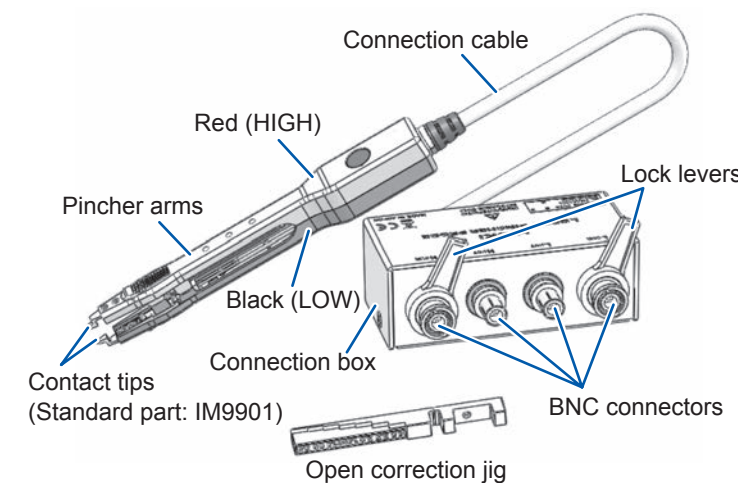

Specifications

Operating environment	Indoors, altitude up to 2,000 m (6,562-ft.)
Operating temperature and humidity	0°C to 40°C /32°F to 104°F, 80%RH or less (non-condensating)
Storage temperature and humidity	-10°C to 55°C, 14°F to 131°F, 80%RH or less (non-condensating)
Dimensions	Connection cable length: approx. 730 mm /28.74" (Treated as 1 m during cable length correction.) Pincher arms: approx. 19W×19H×146D mm/ 0.75"W×0.75"H×5.75"D (Excluding protruding parts) Connection box: approx. 96.5W×45.5H×36.5D mm /3.8"W×1.79"H×1.44"D (Excluding protruding parts)
Mass	Approx. 190 g/ 6.7 oz.
Product warranty period	1 year
Connection to measuring instrument	4-terminal-pair design Connectors: BNC (connector spacing: 22 mm/ 0.87")
Contact with sample	2-terminal design
Tip spacing	0.3 mm/ 0.01" to approx. 6 mm/ 0.24"
Measurement sample size (recommended)	Model IM9901 Contact Tips (with standard tips): 1608 to 5750 (JIS)/ 0603 to 2220 (EIA) Model IM9902 Contact Tips (with optional tips): 0603 to 5750 (JIS)/ 0201 to 2220 (EIA)
Characteristic impedance	50 Ω (model L2001) 75 Ω (model L2001-01)
Maximum input voltage	±42 V peak (AC+DC)
Maximum input current	±1 A peak (AC+DC)
Usable frequency range	DC to 8 MHz (model L2001) DC to 5 MHz (model L2001-01)
Residual parameter values (reference values)	Capacitance: 1 pF or less Inductance: 0.5 μH or less Resistance: 50 mΩ or less
Accessories	• Instruction Manual 1 • Open correction jig 1
Options	• Model IM9901 Contact Tips 1 set Dimensions of measurable samples: 1608 to 5750 (JIS)/ 0603 to 2220 (EIA) • Model IM9902 Contact Tips 1 set Dimensions of measurable samples: 0603 to 5750 (JIS)/ 0201 to 2220 (EIA)

Effect on measurement accuracy

The following table gives the accuracy when combined with the connected measuring instrument. The base accuracy depends on the connected instrument.

□: spec. ×1 ●: spec. ×2.5 ▲: spec. ×3

Freq. Range	4 Hz -	100 Hz -	1,001 kHz -	10.01 kHz -	100.1 kHz -	1,001 MHz -
100 MΩ	●	●	●	●	●	●
10 MΩ			●	●	●	●
1 MΩ				●	●	●
100 kΩ					●	●
10 kΩ						
1 kΩ						
100 Ω						
10 Ω	▲	▲	▲	▲	▲	▲
1 Ω	▲	▲	▲	▲	▲	▲
100 mΩ	▲	▲	▲	▲	▲	▲

Connection Method

Inspection Before Use

Before using the device, verify that it operates normally to ensure that no damage occurred during storage or shipping. If you find any damage, contact your authorized Hioki distributor or reseller.

CAUTION

- When disconnecting the BNC connector, be sure to release the lock before pulling off the connector. Forcibly pulling the connector without releasing the lock, can damage the BNC connector.

Connect the Pincher Probe's connection box to the measuring instrument.

- Align the connection box's BNC connectors with the measuring instrument's BNC connectors and insert.

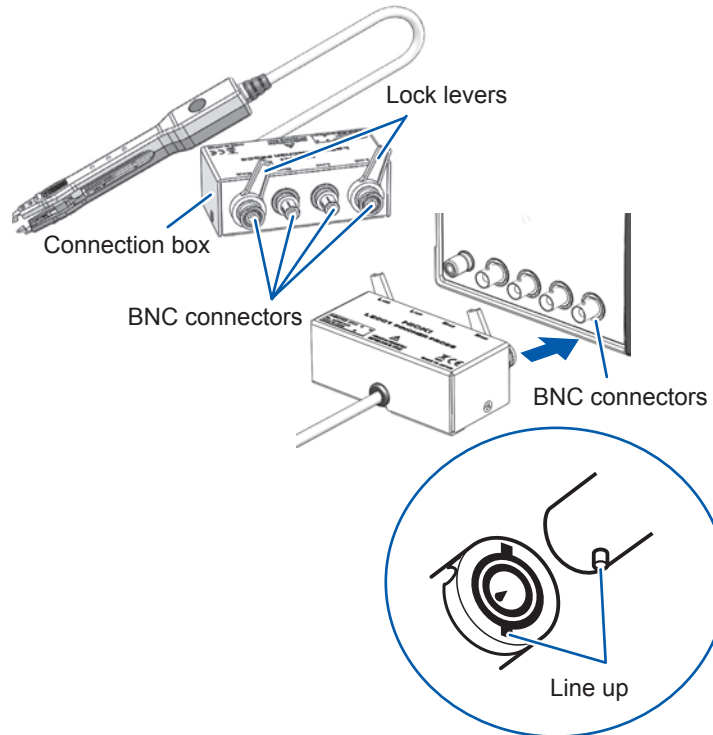

- Twist the lock levers to secure the connection box to the measuring instrument.

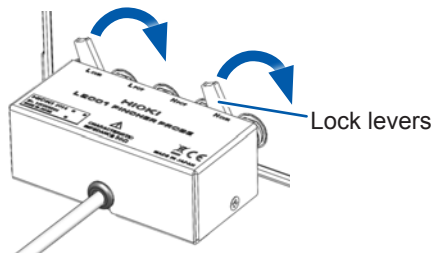

Correction Method

Open correction and short correction are performed in order to increase measurement precision. The correction method varies with the measuring instrument with which the probe is being used. Refer to the instruction manual that came with the instrument.

IMPORTANT When using a measuring instrument that can perform cable length correction, set the cable length to 1 m.

Open Correction

You will need: Open correction jig

- Check the length of the sample being measured.

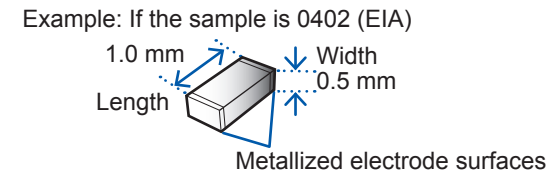

- Select the position on the open correction jig whose label corresponds to the length of the sample being measured, insert the tips of the pincher arms as far as they will go, and squeeze the arms together.

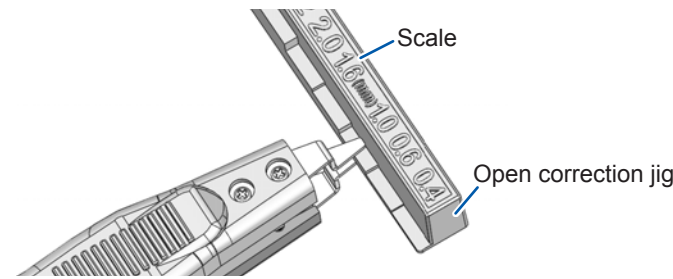

- Perform correction with the measuring instrument.

Short Correction

- Squeeze the pincher arms together so that the tips are shorted.

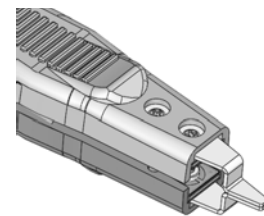

Measure an impedance before performing short correction. If the measured value is comparatively unstable, perform the following method.

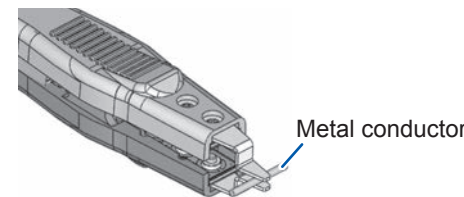

To ensure contact stability, hold a metal conductor with a thickness of 0.3 mm or more between the contact tips.

- Perform correction with the measuring instrument. Place the C-shaped part of the open correction jig around the pincher arms to hold the tips together as necessary.

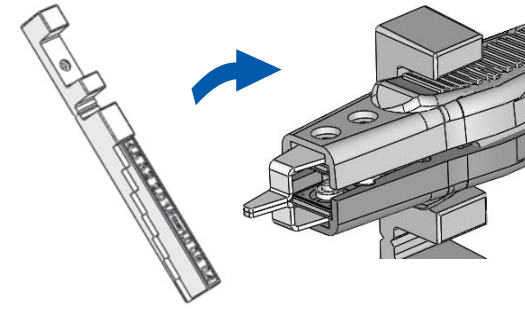

Measurement Method

CAUTION

- If using the L2001 or L2001-01 in combination with the DC Bias Voltage Unit 9268-10 or 9268, respectively, do not short-circuit the contact tips of the device with DC voltage (DC bias) applied. Doing so will cause the device or the instrument to which the device is connected to be damaged.
- To prevent damage to the device, do not subject the tips of the pincher arms to mechanical shock.

Squeeze the pincher arms together around the sample and read the measured value.

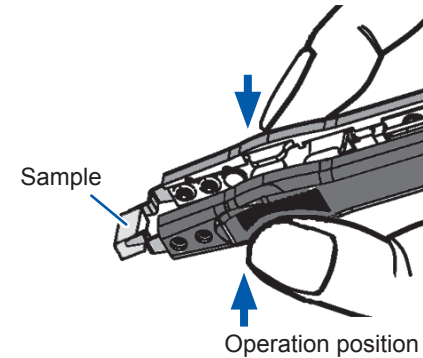

IMPORTANT

- Apply an appropriate amount of force at the position shown in the figure to squeeze the pincher arms around the sample. The contact resistance value will vary with the amount of force applied. The effect of contact resistance is particularly pronounced when measuring low-impedance elements or performing short correction.
- Clean the tips of the pincher arms and the surface of the sample before performing short correction or making a measurement. The presence of dirt could result in poor contact, making accurate measurement impossible.
- It is recommended to use guarding when performing open correction and when measuring high-impedance elements as those operations are particularly susceptible to the effects of external induced noise and stray capacitance. Guarding methods include making measurements on a metal plate that has been connected to the guard terminals. For more information, refer to the instruction manual that came with the measuring instrument being used.

Contact Tip Replacement Method

CAUTION

- Attach the tips with an appropriate amount of tightening torque. Use of an inappropriate tightening torque may damage the probe or cause poor contact.
- When turning the screws with a screwdriver, support the arm from the bottom so as to prevent an excessive amount of force from being applied to the base.

When installing the optional IM9902 tips or when wear or other factors have rendered the contact tips unusable, they can be replaced using the following method: You will need: No. 0 precision Phillips head screwdriver, replacement contact tips

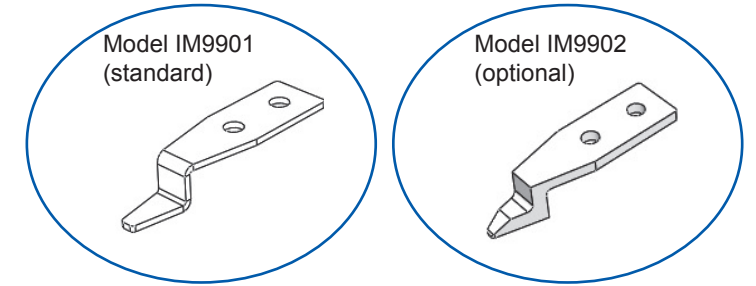

- Loosen and remove the two screws with the screwdriver.

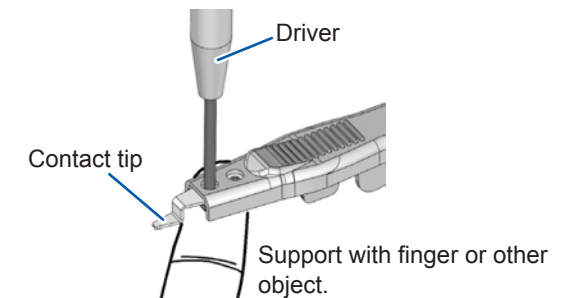

- Pull each contact tip in the direction indicated by the arrow to remove it.

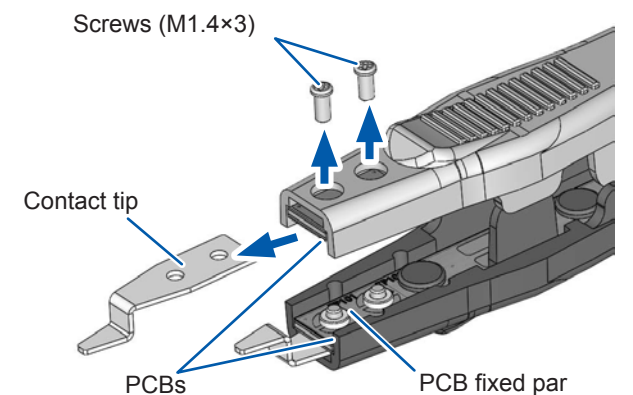

- Attach the replacement contact tips. When you do so, align the holes in each tip with the holes in the corresponding pincher arm.
- Align the position of the top and bottom tips.
- Tighten the two screws with the screwdriver. Tightening torque: 0.06 N·m