

REED

Model CM-9930

True RMS AC/DC

Clamp Meter

Instruction Manual



[www reedinstruments com](http://www.reedinstruments.com)

Table of Contents

Safety	3
Features.....	4
Specifications.....	4-6
Instrument Description	6-7
Operating Instructions.....	8-11
<i>DC/AC Measurements</i>	8
<i>Resistance Measurement</i>	8
<i>Continuity Check</i>	8
<i>Diode Test</i>	8-9
<i>AC Current Measurement (Clamp-on)</i>	9
<i>DC Current Measurement (Clamp-on)</i>	9
<i>AC Current Measurement (Direct input)</i>	10
<i>DC Current Measurement (Direct input)</i>	10
<i>Capacitance Measurement</i>	10
<i>Frequency Measurement</i>	10
<i>Duty Cycle Measurement</i>	11
<i>Zero Adjustment</i>	11
<i>Data Hold Operation</i>	11
<i>Relative Operation</i>	11
<i>Backlight Operation</i>	11
Fuse and Battery Replacement.....	12

Safety

To ensure safe operation and service of this meter, follow these instructions:

- Ensure that the DC 9V battery is connected to its snap terminal with the right polarity and correctly placed in the battery compartment
- Place the Red and Black test leads into the proper input terminal before taking any measurements
- Remove one of the test leads from the circuit before changing the measurement range
- Be sure to release the data hold button before taking a new measurement otherwise the display reading will freeze permanently
- Do not allow the input terminal to exceed the maximum rated voltage
- Always switch the function rotary switch to the OFF position when the instrument is not operation
- Remove the battery if the instrument will not be used for an extended period of time
- Even though the ohm and capacitance ranges have an overload protection circuit, it is prohibited to apply any voltage to the input terminal when taking measurements
- The water resistance casing is applicable for the front panel on the instrument only. Do not throw the instrument into water or the meter will be damaged permanently
- When changing the test leads you should only use the replacements that have the approval of CAT III-1000V
- Only use a dry cloth to clean the plastic case



Caution: Risk of electric shock.



Caution: Do not apply overload voltage or current to the input terminal. Always remove test leads before opening the battery cover.

Features

- 2 in 1, 2000A clamp meter and digital multimeter
- LSI circuit provides high reliability and durability
- Overload protection circuit is provided for all ranges
- Compact & heavy duty ABS and fireproof plastic case
- Installation category III
- Pollution degree 2
- Altitude up to 2000 meters

Specifications

Display:	15mm (0.6") 4 digit LCD, max indication 4000
Measurement Range:	AC, DC, ohms, diode, Hz, capacitance, duty cycle and continuity beeper
Polarity:	Automatic Switching, "-" indicates negative polarity
Current Sensor:	Hall effect sensor
Zero adjustment:	DC: Push button adjustment Other ranges: Automatic adjustment
Over-input:	Indication of "1" or "-1"
Sampling Time:	Approximately 0.35 seconds
Operating Temp:	0°C to 50°C (32°F to 122°F)
Operating Humidity:	Less than 80% RH
Max. Jaw Open Size:	60mm (2.36") diameter
Weight:	380g/0.85lb (including battery)
Dimensions:	255 x 73 x 38mm (10 x 2.9 x 1.5")
Power Supply:	One 9V battery (included)
Power Consumption:	Approximately DC 5mA
Includes:	TL-88-1 test leads, one 5 x 20mm 500mA fuse, and one 6AM6X 9V battery
Optional Accessories:	Carrying Case (Model CA-05A)

Electrical Specifications

Function	Range	Resolution	Accuracy	Overload Protection
DC/AC Voltage (DC only)	400mV	0.1mV	$\pm (0.5\% + 2d)$	AC/DC 1000V
	4V	0.001V	DC:	
	40V	0.01V	$\pm (1\% + 2d)$	
	400V	0.1V	AC:	
	1000V	1V	$\pm (1.2\% + 5d)$	
DC/AC Current (Direct input)	400uA	0.1uA	$\pm (1.2\% + 5d)$	AC/DC 500mA
	4000uA	1uA		
	40mA	0.01mA		
	400mA	0.1mA		
DC/AC Current (Clamp on)	400A	0.1A	$\pm (2\% + 5d)$	AC/DC 2000A/1000V
	2000A	1A	$\pm (2\% + 8d)$	
Ohms	400 ohm	0.1 ohm	$\pm (1\% + 5d)$	AC/DC 400V
	4K ohm	1 ohm		
	40K ohm	10 ohm		
	400K ohm	100 ohm		
	4M ohm	1K ohm	$\pm (2\% + 2d)$	
	40M ohm	10K ohm	$\pm (3.5\% + 5d)$	
Capacitance	50nF	10pF	$\pm (3\% + 5d)$ * See Notes On Following Page	AC/DC 400V
	500nF	100pF		
	5uF	0.001uF		
	50uF	0.01uF		
Frequency (>5V)	5Hz	0.001Hz	$\pm (1\% + 5d)$	AC/DC 1000V
	50Hz	0.01Hz		
	500Hz	0.1Hz		
	5KHz	1Hz		
	50KHz	0.01KHz		
	100KHz	0.1KHz		
Duty Cycle	1% to 99%	0.10%		
Diode	Short/non conductance, good/detect test			
Continuity	Meter will beep if measuring resistance is less than 10 ohm			

Notes:





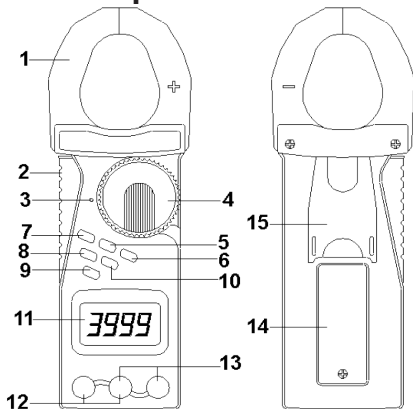





- True RMS measurement for AC measurements
- Input impedance for AC/DC range is 10M ohm
- AC frequency response is from 45 to 1KHz
- AC specification is tested on sine wave 50/60Hz
- Specifications are tested under the environment RF Field Strength less than 3V/M and frequency less than the 30MHz only
- The accuracy of the capacitance ranges are after the zero adjustment (see page 11) has been executed

Instrument Description



- | | |
|-------------------------------|-----------------------------------------------------------------|
| 1. Clamp jaws | 10. Manual range select button |
| 2. Trigger | 11. Display |
| 3. Function indicator | 12. μ A/mA direct current input terminals |
| 4. Function rotary switch | 13. V, ohm, Hz, diode, continuity & capacitance input terminals |
| 5. DC zero button | 14. Battery cover/compartament |
| 6. Relative button | 15. Stand |
| 7. Data hold/backlight button | |
| 8. V/Hz/% (duty cycle) button | |
| 9. Function button | |

Display Description

Symbols/ Units	Descriptions
	Appears when selecting DC modes
	Appears when selecting AC modes
	Appears when the data hold function is active
	Appears when the relative function is active
	Appears when battery voltage is low
	Appears when the automatic range mode is active
	Appears when the continuity beeper is active
mV, V	Units for voltage measurements
Ω , K Ω , M Ω	Units for resistance measurements
	Appears when the diode function is active
	Appears when measuring negative DC values
	Backlight is on
%	Unit for duty cycle measurements
μ A, mA, A	Units for current measurements
Hz, KHz	Units for frequency measurements
nF, μ F	Units for capacitance measurements
	Appears when operating clamp-on current measurements

Operating Instructions

DC/AC Measurements

Connect the Black test lead into the COM terminal. Connect the Red test lead into the V terminal. If measuring DC, move the function rotary switch to the V position and press the function button until the display shows --- . If measuring AC, move the function rotary switch to the V position and press the function button until display shows \sim .

Resistance Measurement

Connect the Black test lead into the COM terminal. Connect the Red test lead into the Ω terminal. Move the function rotary switch to the Ω position and press the function button until the display shows Ω .

Note: When LCD displays **AUTO**, the meter is in auto range mode, meaning the meter will now automatically select the suitable measurement range. While in auto range mode, press the range button to hold the range.

Continuity Check

Connect the Black test lead into the COM terminal. Connect the Red test lead into the Ω terminal. Move the function rotary switch to the $\bullet|||$ position and press the function button until the display shows $\bullet|||$.

Note: A beep will sound when the resistance value is less than 10 ohm

Diode Test

Connect the Black test lead into the COM terminal. Connect the Red test lead into the $\rightarrow|+$ terminal. Move the function rotary switch to the $\rightarrow|+$ position and press the function button until the display shows $\rightarrow|+$.

a) When connected with the polarity as shown in Fig. 1, a forward current flow is established and the approximate diode forward Voltage (VF) value, in volts, will appear on the display. If the diode under test is defective a value near .000 (short circuit) or 1 (open circuit) will be displayed.

b) When connected as shown in Fig. 2, a reverse check on the diode is made. If the diode under test is good a 1 will show on the display. If the diode under test is defective, .000 or other numbers will be displayed. Proper diode testing should include both steps a and b

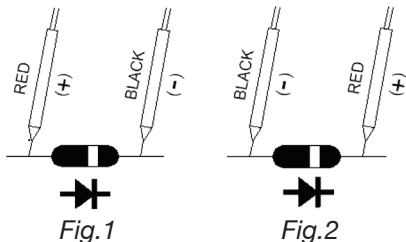

AC Current Measurement (Clamp-on)

Move the function rotary switch to the 2000A position and press the function button till the display shows \sim . Press the trigger to open the current sensor jaws and clamp it around the measuring conductor only

DC Current Measurement (Clamp-on)

Move the function rotary switch to the 2000A position and press the function button until the display shows \equiv . Push the DCA Zero button for at least 2 seconds to display a value of zero. Press the trigger to open the current sensor jaws and clamp it around the measuring conductor only

Note: It is recommended to use the auto range mode during measurements. If you press the range button during auto range mode the meter will hold the range. For your safety please insert the terminal rubber cover (Fig. 3) for protection.



Fig.3

AC Current Measurement (Direct input)

Connect the Black test lead into the COM terminal. Connect the Red test lead into the μA , mA terminal. If measuring μA (400 μA , 4000 μA), move the function rotary switch to the μA position and press the function button until the display shows .

If measuring mA (40mA, 400mA), move the function rotary switch to the mA position and press the function button until the display shows . Open the circuit where the current to be measured is located and securely connect the test lead in series with the circuit



DC Current Measurement (Direct input)

All the measuring procedures are same as AC current measurement, except press the function button until the display shows .

Note: The maximum value that can be measured for direct input current value is AC/DC 400mA. Do not exceed the input current value more than 400mA otherwise the protection fuse will break. When taking a direct input measurement and the meter shows a value of 0, check if the protection fuse is broken.

Capacitance Measurement

Note: Due to the possibility of any existing stray capacitance on the internal circuit board or in the test alligator (for the 50nF and 500nF range) you should always do the zero adjustment procedure before making any measurements.

Connect the Black test lead into the COM terminal. Connect the Red test lead into the  terminal. Move the function rotary switch to the  position and press the function button until the display shows nF. During a capacitance measurement the meter will always perform under the auto range mode.

Frequency Measurement

Connect the Black test lead into the COM terminal. Connect the Red test lead into the Hz terminal. Move the function rotary switch to the Hz position and press the Hz/% button until Hz is displayed on the screen. During a frequency measurement the meter will always perform under the auto range mode.

Duty Cycle Measurement

All the measuring procedures are same as a frequency measurement except press the Hz/% until the display shows %.

Zero Adjustment

Open the input terminal and the capacitor that is not connected and press the relative button until the display shows a value of zero. Connect the measuring capacitor again and take your measurement.

Data Hold Operation

Press the hold button and the displayed value will hold and **H** will appear. Press the hold button again to release the data hold function.

Relative Operation

While taking a measurement the meter will store the last measured value. Press the relative button once and LCD will show a value of zero **REL**. The newly inputted measured values will automatically be deducted from the last measured values and those new values will appear on the display. To release the relative measurement function press the relative button, and the **REL** marker will disappear.

Backlight Operation

Push the backlight button for about two seconds for the LCD to illuminate.

Fuse and Battery Replacement

Fuse Replacement

- 1) The meter is provided with one 5 x 20mm 500mA fuse for current (direct input) measurements and current range overload protection purposes
- 2) When the direct input current range isn't operating check to see if the fuse is broken
- 3) To replace the fuse, open the housing case and remove the fuse from the main PC board
- 4) Replace the fuse according the specifications and replace the housing case

Battery Replacement

Caution: Remove test leads before opening the battery cover

- 1) When the LCD display shows **+ -** you will need to replace the battery
- 2) Loosen the screw on the battery cover by screwdriver and remove the battery
- 3) Replace with 9V battery and replace the cover

Notes

Notes

For service on this or any other REED product or information on other REED products, contact REED Instruments at info@reedinstruments.com