

## CONTINUATION

Dear User,

We're pleased for your patronage of purchasing SEH Series Rope Tension Meter. Before using the instrument, please read the manual carefully and keep it well to give you help when you can't learn it or there is something wrong with it.

Description in the manual is based on the newest products. Owing to improvement or other changes, contents of manual may differ from practical situation. Our company will reserve the right of recension at any moment. Please kindly forgive not to notify the revised places one by one.

The copyright of this manual belongs to Wenzhou Sundoo Instruments Co., Ltd. Any companies or individuals have no rights to copy or plagiarize part or whole contents of the manual without permission of our company.

SEH Series  
User Manual

绳 索 张 力 计  
ROPE TENSION METER

制造商：温州山度仪器有限公司

**MANUFACTURER: WENZHOU SUNDOO INSTRUMENTS CO.,LTD**

地址：浙江省温州市龙湾区西台工业区西工西路5号

Add:No.5,Xigongxi Road,Xitai Industrial Zone,Wenzhou China

Zip:325011

Tel:+86 577 88609905 Fax:+86 577 88390155

Http://www.sundoo.com E-mail:export@sundoo.com



## Maintenance

1. Please clean the instrument with soft cloth. Put dry cloth into water with detergent , then clear dust and dirt after drying wet cloth . Don't use volatile chemicals, such as naphtha , thinner, alcohol.
2. Handle with care during using and carrying.
3. Don't tear down, fix, and reform this instrument by yourself. These behaviors may cause permanent fault of this instrument.
4. When fault happens, please contact original purchasing place or our company.

## Packing List

Item	Name	Quantity
1	Body	1
2	Power Adapter	1
3	Strap	1
4	Straight-through RS-232 Cable with Two-sided Holes	1
5	CD	1
6	Manual	1
7	Qualification Card	1

Thanks for your patronage to purchase SEH Series Rope Tension Meter. With high accuracy and high resolution, this meter is a new universal and portable rope tension instrument. It can set freely and judge automatically the qualified values. This meter has built-in yellow/green indicator lamp and buzzer, and it will alarm with sound and light if exceeding the limits. It can turn on/off the blue background light. The meter can preset 10 groups of rope specifications, and each specification can at most store 10 groups of test data. It has the function of calculating the average. It can convert three units (KN, tf, klbf) automatically. It can back up and recover the rope specifications. It can also provide self-calibration for the rope specifications. The meter can turn off automatically if it has no operation, and the shutdown time can be set freely. It supports RS-232C output. It can print the test data of single rope specification or 10 groups of rope specifications if it connects to external printer. It can also import the test data of single rope specification or 10 groups of rope specifications if it connects to computer. This meter is applied in tension test of various ropes. Before using this instrument, please read the manual carefully so that you can make full use of this instrument and get accurate load value.

## CONTENT

Parameter .....	2
Structure .....	3
Dimension .....	3
Function .....	4
Main Characteristic .....	4
Work Environment.....	5
Parts Appellation and Function .....	5
Test Preparation .....	8
Test .....	9
Self-calibration and Backup Data Recovery .....	11
Serial Port Output and Print .....	13
Rechargeable Battery Group .....	14
Maintenance .....	15
Packing List .....	15

### (3) Specific software operation

- Put accessory CD into computer drive and open software route:  
CD-ROM \ English \ Measuring Software \ SundooPort\_ Ver2.00 \ SundooPort.exe. The interface is as Picture 8.
- In the box of "Serial Port Setting", choose designated COM as the picture "COM: COM1", and you don't need to change other parameters. If you want to change, please refer to the picture.
- If you click "OPEN", the data of "Serial Port Setting" will be grey and any changes are not allowed.
- Pressing "PRINT" button on the instrument can upload the stored test values. The test values and analysis report will be shown on the white box of "Receive Message".

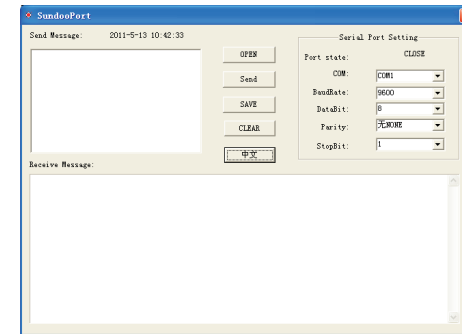

Picture 8

### Rechargeable Battery Group

During using the gauge, if the mark “” flicker, it means that the battery is very low and need to be charged. Please use matched “DC 12V/400mA” charger. With smart charging technology, it will stop charging automatically after charging fully. Practically protect the battery durability.

#### Cautious

- Frequent and long-playing charging will shorten battery life.
- Please charge when the battery only has a grid or less a grid power to avoid not to charge fully because of very low power.
- Charge the battery fully at least once three months.

### Serial Port Output and Print

This instrument is RS-232C level output, which can be connected with micro printer, computer or other outside devices. The matching micro printer must support RS-232 electrical level.

- When setting the serial port output mode as "Print", press "PRINT" button and the screen flickers and displays "PRINT", printing out the stored test values and analysis report (See Picture 7) of current rope specification. If you press "PRINT" more than 3 seconds, the screen flickers and displays "PRINT", printing out the stored test values and analysis report of all the rope specifications.

Illustration of RS-232 Port

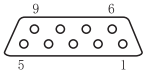

Needle	Signal	Illustration
2	TxD	Output signal of scm
3	RxD	Incept signal of scm
5	GND	Earth

Print Sample

```

Title -----SEH-5T TEST REPORT-----
Data for memo Date:
No:
Unit Unit:KN
Specification Diam:10
01 5.60 OK
Value 02 6.50 OK
03 7.80 OK
OK: Eligible 04 8.60 OK
05 9.30 OK
Max Max: 9.30
Min Min: 5.60
Average Average:7.5
Factory -----SUNDOO INSTRUMENT WWW.SUNDOO.COM-----
    
```

Picture 7

- When setting the serial port output mode as "PL", connect the instrument with computer by the straight-through RS-232 cable, which has two-sided holes. Then open the serial port software (Sundoo Port) and set the parameters, and pressing "PRINT" button can upload the stored test report of current rope specification and pressing "PRINT" button more than 3 seconds can upload the stored test report of all the rope specifications. The specific operations are as follow.
  - Hardware environment
    - CPU: Celeron 1G or above.
    - Memory: 256MB or above.
    - Hard disk available capacity: 300MB or above.
    - Drive: CD-ROM or DVD-ROM.
  - Software environment
    - Operating system: Windows XP (32bit).

### Parameter

Model	SEH-20T	SEH-10T	SEH-5T	SEH-2T						
Capacity	200 KN	100 KN	50KN	20 KN						
Resolution	0. 1KN	0. 05KN	0. 01 KN	0. 01 KN						
Rope Specification	Φ18~Φ36	Φ14~Φ32	Φ10~Φ28	Φ6~Φ16						
Test Range	10%-100%FS									
Accuracy	Within ±5%									
Unit	KN, tf, klbf									
Sensor Type	Sensor Inside									
Power	Adaptor: DC 12V/300mA Battery inside: Ni-Hi 8.4V 1200mAh									
Use Time	Cortinuous use for about 40 hours									
Standby Time	About 3 months									
Battery Life	≥300 times									

Structure

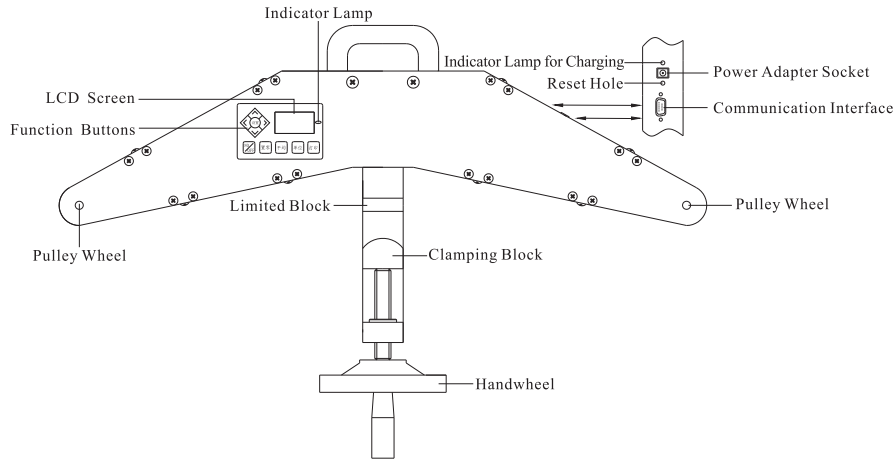

Dimension

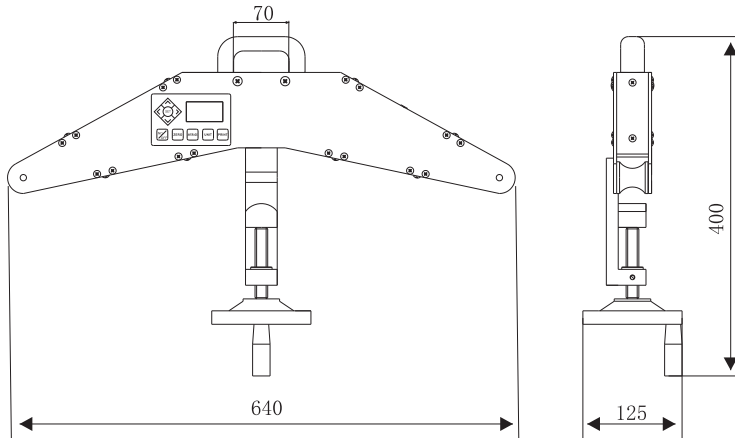

environment of lower than 90% Relative Humidity and -20~+60°C for next use. and calibrate the rope for the force of corresponding percentage range. After calibrating the point of 102% range, the screen will return to 00 calibration point interface (See Picture6). It means that the parameters of current rope specification have been calibrated, and "✓" means that the calibration parameters of current rope specification have been changed.



Picture 6

- E. After calibrating the parameters of first rope specification, press "PRINT" button and "▶" will move up to point at the second rope specification. Repeating Procedure B, C, D can calibrate the parameters of second rope specification. Each time you finish calibrating the parameters, you can press "PRINT" button to point at the next rope specification.
- F. After calibrating the parameters of tenth rope specification, pressing "PRINT" again can exit the self-calibration mode. In addition, after calibrating the parameters of one rope specification, if you want to give up calibrating the parameters of surplus rope specifications, you can press "PRINT" repeatedly until exiting the self-calibration mode.

At the same time, this instrument has the function of backup data recovery so that you can make the calibration parameters recover to original values. The specific operations are as follow: In the normal test state without force, pressing "SET" repeatedly until the screen shows "r.dAtA". Press "✓" to make the digital box show "YES", and press "PRINT" to make it show "rAtE", then the instrument will restart and finish backup data recovery after two seconds.

Note: Please be sure to do the self-calibration and backup data recovery when the battery is full.

## Self-calibration and Backup Data Recovery

This instrument has 10 groups of calibration parameter, and you can calibrate the rope specification according to your requests. The specific operations are as below.

- A. In the state of power off, press " $\text{ON/OFF}$ " button to turn on the instrument, then press " $\text{HOLD}$ ", " $\text{PRINT}$ " and " $\text{ZERO}$ " one by one so as to enter into self-calibration in-terface (See Picture 4). S10 on the screen is the rope specification, and pres-sing " $\text{◀▶}$ " can change the current rope specification (cycle from  $\phi$  00-  $\phi$  60). 00 is the calibration point location (It has 6 calibration point locations: 00-0% range, 01-20% range, 02-40% range, 03-60% range, 04-80% range, 05-100% range). The digital box 0.00 is the calibration data, and pressing " $\text{▲▼}$ " can change current calibration data. " $\blacktriangleright$ " points at the calibration state of first rope specification.
- B. Now, keep the hand wheel down vertically, and pressing " $\text{UNIT}$ " can store the corresponding calibration parameter of this instrument 0.00 KN (0 % range), then it enters into the next calibration point (20% range) location automatically (See Picture 5).

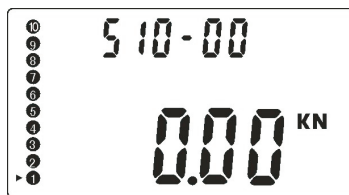

Picture 4



Picture 5

C. You can set the corresponding value of 20% range in the digital box by pressing " $\text{▲▼}$ " according to your requests. After setting, put 20% range of rope in the notches of pulley wheel, tighten the hand wheel in clockwise di-rection to make the rope upward to the limited block, press " $\text{UNIT}$ " button to store the calibration parameters and enter into the next calibration point (40%range) location, then fallback the hand wheel to release the rope in anticlock-wise direction.

D. Repeat the Procedure C, set the value of corresponding percentage range. After the test, press " $\text{ON/OFF}$ " button to turn off the instrument and put it in the en-



Wrong operation may destroy this gauge or lead to grave accident. This manual teaches you how to avoid accidents and use this instrument. Please read this manual carefully before using it. Please keep it properly after using it. The effective measurement range of this instrument is 10%~100%of full range.



1. Please check the attached strap of the instrument before using in order to avoid any accidents.
2. When testing the tension force of rope, do not over tighten hand wheel gearing. Otherwise the sensor may be damaged.
3. "Error" on LCD screen means that the sensor load has already exceeded 102% of rated load, and please reduce load immediately. When turning on the instrument, please don't allow more than 2% of the rated load.
4. Don't use it with overload. Usage of overload, shock load of overload and the load besides the directions of push and pull will damage sensor.
5. Do not press the button with pointed tools (like Picture 1).
6. This instrument is used to test the tension of rope (like Picture 2). Do not force on the hand wheel in left or right direction (like Picture 3).

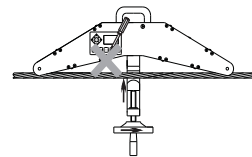

Picture 1

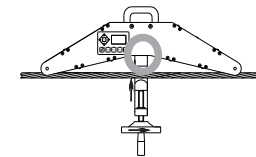

Picture 2

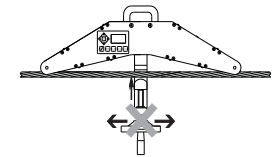

Picture 3

7. Do not use the instrument near water, oil or other liquids. Please keep it in a shady, dry and stable place.

## Function

SEH Series Rope Tension Meter is a new universal and portable testing instrument. With compact size, taking easily, multifunction and high accuracy, it can be used to test the tension of various ropes.

## Main Characteristic

1. High accuracy and high resolution.
2. Free setting and automatic judging for qualified values; red/green indicator lamps and buzzer can alarm automatically with light and sound.

3. Turn on/off the blue background light.
4. Preset 10 groups of rope specifications, and each group can store 10 test data and calculate the average.
5. Convert three units (KN, tf, klb) automatically.
6. Backup, recover and self-calibrate the rope specifications.
7. It can turn off automatically if it has no operation, and the shutdown time can be set freely.
8. RS-232C output. Connecting to external printer can print the test data of single rope specification or 10 groups of rope specifications. Connecting to computer can export the test data of single rope specification or 10 groups of rope specifications.

### Work Environment

- 1、Work temperature: 20°C ± 10°C ;
- 2、Relative humidity: 35%RH~65%RH;
- 3、No shock and corrosivity materials around.

### Parts Appellation and Function

#### 1. LCD

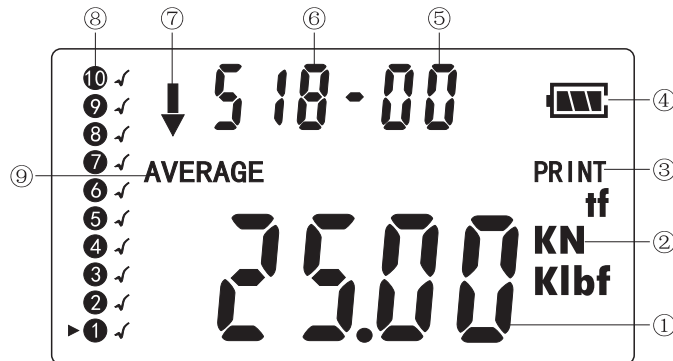

- ① Test value or average of tension meter. Under setting status, it displays set value.
- ② Unit: Three units (KN, tf, klb) can convert automatically.
- ③ Printing/exporting the test data of single rope specification or 10 groups

Press "SET" for the fourth time, the screen will display "LIGHT", and the digital box displays the state ("ON" or "OFF") of current background light. Pressing "✓✓" can change the current state.

Press "SET" for the fifth time, the screen will display "PC", and the digital box displays current serial port output mode ("PC" or "Print"). Pressing "✓✓" can change the current state.

Press "SET" for the sixth time, the screen will display "REAR", and the digital box displays the switch ("YES" or "NO") of current backup data recovery. Pressing "✓✓" can change the current state.

Press "SET" for the seventh time, all the settings will be saved and the instrument will return to the normal test state.

Note: In the setting state, pressing "ZERO" button can store all the settings and return the normal test state.

#### 5. Tension test

Press "✓✓" button to choose your required rope specification, press "◀▶" to choose the storage cell of test value, put the rope in the notches of pulley wheel and tighten the hand wheel in clockwise direction to make the rope upward to the limited block, then the screen will show the largest tension value (as the picture below). Fall back the hand wheel to release the rope in anticlockwise direction, and the digital box will show the current test value all the time. Pressing "ZERO" can clean to zero and will not store current test value; pressing "◀▶" can store the current test value and choose the next storage cell.

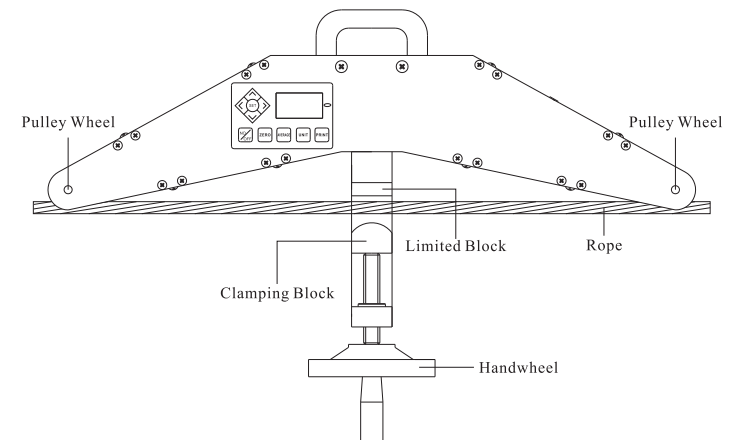



gearing should not loose, then make the clamping block close to the limited block by tightening the hand wheel in clockwise direction, so as to lie in the same vertical center line.

## Test

### 1. Turn on the power

ON: Under shutdown status, press "ON/OFF" to start the instrument. After power on, it firstly enters into self-checking program, and the screen will display "SUNDOO" and the instrument model (If you press "▲" button now, the screen will show the version number "Ux.xx" of built-in program), then the instrument enters into normal working status. "▶" points at the first rope specification, and the storage cell of test value points at 00 location.  
OFF: Under power on status, if the instrument isn't used, it will shut down automatically according to the preset shutdown time, and you can also press "ON/OFF" to shut down the power.

### 2. Clean to zero

After power on, if the test value is steady, pressing "ZERO" can clean to zero (The range of cleaning to zero is 2% of the rated load). In the state of showing the stored value, pressing "ZERO" button can delete the current stored value and clean to zero; if you press "ZERO" button for more than 3 seconds, all the stored values of current rope specification will be deleted and clean to zero.

### 3. Select suitable unit

Before testing or during testing, three units (KN, klb, tf) can be switched circularly by pressing the "UNIT" button.

### 4. Setting the qualified value, auto power off time, the number of storage cells, background light, serial port output mode and backup data recovery.

Press "SET" for the first time, the screen will display "PASS.d", and the digital box displays current qualified value. Pressing "▲▼" can change the current value.

Press "SET" for the second time, the screen will display "P.off", and the digital box displays current auto power off time. Pressing "▲▼" can change the current value.

Press "SET" for the third time, the screen will display "n.nor y", and the digital box displays current number of storage cells. Pressing "▲▼" can change the current value.

of rope specifications can be chosen.

### ④ Electric quantity indication of battery

When the power is low, it displays "☐" or flickers, meaning that the battery needs to be charged. When the battery is being charged, the power indication "▲▲▲" will flicker.

### ⑤ Storage location indication of test data for single rope specification

The storage cell is from 00 to 09, and the number of cells is determined by setting parameter.

### ⑥ The reading of the rope specification shows as SXX.

### ⑦ The direction symbol of tension meter is the same with the actual testing direction.

### ⑧ Preset the list of rope specification

"①②③④⑤⑥⑦⑧⑨⑩" include 10 locations, and each location stands for one rope specification.

▶ stands for the rope specification of this location.

√ indicates that this location has stored at least one test value.

### ⑨ The average symbol of stored test data for current rope specification.

## 2. Function Buttons

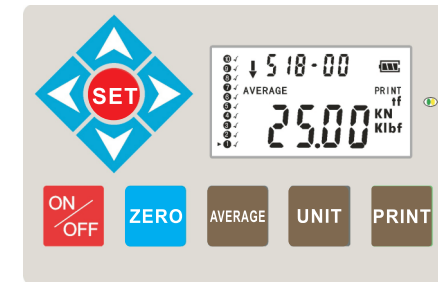

ON/OFF Button



Return to zero, delete the stored value and exit setting mode

- In the test state without force, pressing this button to return to zero.
- When showing stored value, pressing this button can delete the current stored value and return to zero.





- C. In the test state, pressing this button more than 3 seconds can delete all the stored values of current rope specification and return to zero.
- D. In the setting state, pressing this button can exit setting mode and return to test state.





 Count and show the average of stored values for current rope specification.



 Conversion of units



 Print/export the test data of single rope specification or 10 groups of rope specifications.

-  Set Button
- A. Set the qualified value and automatic alarm value.
  - B. Set automatic shutdown time (free setting from 1~60minutes, 0 is not automatic shutdown).
  - C. Set the cell number of storage location, and it can at most set 10 cells (free to set from 00 to 09).
  - D. Set blue background light.
  - E. Set serial output mode.
  - F. Recover the backup data.

-  Up/Plus Key of Rope Specification
- A. In the current test state, pressing "" button can make "" symbol forward one location and enter into the previous rope specification's test state.
  - B. In the setting state, pressing "" can make the set value increase. When the set values shows as digits, pressing this button all the time can make the set value increase continuously.

-  Down/Reduce Key of Rope Specification
- A. In the current test state, pressing "" button can make "" symbol backward one location and enter into the next rope specification's test state.
  - B. In the setting state, pressing "" can make the set value decrease. When the set values shows as digits, pressing this button all the time can make the set value decrease continuously.

-  Backward Key of Cell for Storage Location
- In the test state of current rope specification, pressing "" can make the storage location of test data backward one location. The total number of cells is determined by the parameters of setting items, and it at most has 10 storage location (00-09) and cycle storage mode.

-  Forward Key of Cell for Storage Location
- In the test state of current rope specification, pressing "" can make the storage location of test data forward one location. The total number of storage cells is determined by the parameters of setting items, and it at most has 10 storage location (00-09) and cycle storage mode.

### 3. Indicator Lamps

Under the state of normal test, when the test value reaches to preset qualified value, the green indicator lamp will light; when the test value is lower than qualified value, the green indicator lamp will extinguish automatically; when the test value exceeds the capacity of the instrument, the orange indicator lamp will light and remind users to reduce the force immediately in case of damaging the inside sensor.

### 4. Communication Interface

RS-232C serial port output, used to connect printers or computers (See Page 12).

### 5. Power Adapter Socket



Applied power adaptor DC 12V, 300mA.

### 6. Reset Hole

Used to restart the instrument when it is disturbed strongly.

## Test Preparation

### 1. Check the power supply

Turn on the instrument and check the battery, if it shows "" on LCD screen, it means lack of electricity, and the battery group needs to be charged. The method is as follow: Please put the matched power adaptor into the charging port, and plug into AC 220V/50HZ outlet. If "" flickers, it means that it is being charged. This instrument has intelligent charging technology, and it can stop charging automatically when charging fully. It can be charged no matter power on or off.

### 2. Check the hand wheel gearing

Before testing the tension of ropes, please make sure that the hand wheel