

后 续 CONTINUATION

尊敬的用户：

承蒙惠顾，购得SN系列指针式推拉力计。在使用本仪器前，请仔细阅读此说明书，以便能正确使用仪器的全部功能。并请妥善保存说明书，以备有不了解或故障时，能给你带来帮助。

本说明书中的资料均以最新产品为依据，由于改进或其他变化，本说明书的描述可能与实际情况稍有出入，我公司将保留随时修改的权利，修改之处恕难一一相告。

本说明书版权属温州山度仪器有限公司。未经许可，任何单位及个人不得复制或抄袭本说明书的局部或全部内容。

Dear User:

We appreciate for your patronage to purchase SN series analog push pull force gauges. Before using the instrument, please carefully read the manual to use it rightly.

Data of the manual is equally had newest product as evidence, because of improvement or other change, description of manual may differ from practical situation. Our company will reserve the right to correct at any moment. It is difficult to list the corrected points one by one.

Copyright of manual belongs to Wenzhou Sundoo Instrument Co., Ltd. Any unit or individual can't copy or plagiarize the part or full content of manual without permission from us.

制造商：温州山度仪器有限公司

MANUFACTURER: WENZHOU SUNDOO INSTRUMENTS CO.,LTD

地址：浙江省温州市龙湾区西台工业区西工西路5号

Add:No.5,Xigongxi Road,Xitai Industrial Zone,Wenzhou China

Fax:+86 577 88390155 Zip: 325011

Tel:400 826 0705 E-mail:sundoo@sundoo.com (中国)

Tel:+86 577 88609905 E-mail:export@sundoo.com (International)

Http://www.sundoo.com

Ver:1.09 Con:20170719

SN SERIES USER'S MANUAL

SN系列

使用说明书

指针式推拉力计

ANALOG PUSH PULL FORCE GAUGE

Maintenance

1. The clamp made for testing must be able to support the load value of the gauge. When load capacity isn't enough, it will damage the instrument or endanger the safe of testing people.
2. When installing on the other stands to use, please use four M3 screws to fix and install on the gauge, and installed size is [3. Appearance and install size].
3. Please don't apply load exceeding the max test range of gauge to avoid damaging instrument and producing trouble.
4. Don't store or use gauge in the place of low or high temperature and humidity. Please store and use it in the ruled environment.
5. Please store the gauge in the place of solid and level, if you put it in the unstable place, gauge is easily fallen to be damaged.
6. If there's something wrong with it, please contact with original sales department.

Package List

Number	Parts Name	Quantity
1	Main body	1
2	Push clamp	4
3	Drag hook	1
4	Prolong stick	1
5	M3x14 Screw	4+1
6	User's manual	1
7	Factory Inspection Report	1
8	Qualification Card	1

中文……1

ENGLISH……10

非常感谢购买SN系列指针式推拉力计。

本推拉力计是小型简便的推力、拉力测试仪器，具有高精度、易操作及携带方便之优点，而且有一个PEAK/TRACK切换的操作旋钮可做荷重峰值（PEAK）测试及连续荷重值（TRACK）测试，并设有公差带指示器装置，方便批量测试读数。使用本仪器前请仔细阅读此说明书，以便充分运用本仪器所具有的功能，使测试时能得到正确的荷重值。

Thanks so much for purchasing SN Series Analog Push Pull Force Gauge.

The SN series are analog force gauges with compact size and high accuracy. They are easy to operate and handy to carry out. Single click on a knob on the device will convert the movement of the indication needle from the peak force to the track indication, tolerance indication device. They also have tolerance indicator device. It is easy to read the numerous test values. Before using the instrument, please read the manual carefully to use the instrument's function properly, and make gauges work accurately.

3. Load value testing of plural peak — 1

At the beginning, there is a small peak, and then a bigger peak, when do this testing, put knob in the place of [PEAK] first, and then begin test.

When load reaches a definite value and doesn't change, the load value is the first peak. Till to finish the test, the last peak value is second one.

4. Load value testing of plural peak — 2

When there is a big testing peak at the beginning, please make the following two-step test :

a. When changing knob is always in the place of [PEAK], the load value will be always the first peak.

b. Put changing knob in the place of [TRACK] firstly, when load rises again, put changing knob in the place of [PEAK], you can get the litter peak value.

5. When dimness of peak is singular or plural

a. using the method of (1) to confirm the change of force.

b. After confirming the change of (1), and then choose do which testing method fits tested thing among (2), (3), (4) in the test and then make a test.

Others

In order to make gauge have a right and stable tested value, please make full use of clamps attached. If your company wants to manufacture appropriate clamps, please refer to the connected size of central stick shown on the right.

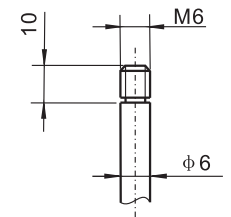

6. Tolerance indication and setting

Turn the two needles on the tolerance indicator to set the tolerance limit (Max.Min). In testing, the needle shows among the range of the tolerance indicator, it is eligible value, or it is incompetent value.

Note: If you often apply a load exceeding the max range of test load to the machine, spring of load test machine will gradually be bad and lead to the wrong test value of load. When using it, please don't overload in order to maintain life of the machine.

Test

Please tightly hold gauge by hands or put it on appropriate stands to make a test. When testing, please adjust tested sample and gauge on the same straight line, if they are not, you will not get the correct tested value of load.

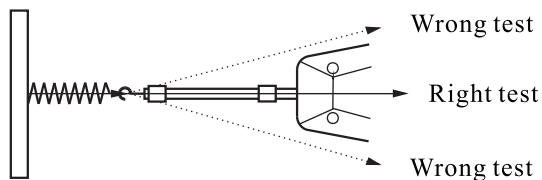

Change of knob and movement of needle

1. Change of load testing

When the knob turns to the [TRACK], the needle moves in accordance with change of force.

2. Load value testing of unitary peak

When changing knob is placed in [PEAK] and the load value reaches, needle will stand still indicating peak force. If unchain the needle, please press changing knob, then needle will return to the place [0].

目 录

规格参数	2
结构名称	3
外形尺寸	4
测试机台	5
测试前准备	6
测试	7
切换旋钮的活用及指针的动作	7
其他	8
保养及维修	8
包装清单	9

规格参数 Technical Specifications

型号 Model	SN-10	SN-20	SN-30	SN-50	SN-100	SN-200	SN-300	SN-500
最大负荷 Capacity	10N	20N	30N	50N	100N	200N	300N	500N
分度值 Resolution	0.05N	0.1N	0.2N	0.2N	0.5N	1.0N	2.0N	2.0N
准确度 Accuracy	±1% FS							
中心轴行程 Stroke	10mm							
工作温度 Work temperature	20±10℃							
运输温度 Transport temperature	-27℃ ~ +70℃							
相对湿度 Relative humidity	15%~80% RH							
工作环境 Work environment	周围无震源及腐蚀性介质 No vibrancy and no cautory around							

Preparation before test

Choose appropriate joint clamp and install it on the gauge before test.

1. Pull and extend test
Choose appropriate pull clamp and install it on the central stick which marked [PULL].
2. Compression
Choose appropriate clamp from push clamps and install it on the central stick which marked [PUSH].
3. Use of prolong stick
When it is impossible to touch the tested thing, use prolong stick to install clamp.

Note: When using prolong stick to test, the tested sample and gauge must be on the same straight line. Or it is impossible to get the right value of load.

4. The Confirmation and the operating method of changing knob
 - a. [PEAK] change into [TRACK]
Lightly press knob changing, at the same time, turn it to left to make the mark "•" be in the place of [TRACK].
 - b. [TRACK] change into [PEAK]
Turn knob to right, the knob springs and the mark "•" is in the place of [PEAK].
 - c. Points for attention after testing
After finishing testing, change the mark "•", please put it in the place of [PEAK]. If changing knob is put in the place of [TRACK] for a long time, life of inner springs lamination will be shorten.
5. Adjustment of indicator dial
 - a. Please confirm whether needle aims at [0] of dial, if not, please turn around the adjustable circle of dial, and dial will run with it to make needle aimed at [0].
 - b. When the machine is vertically placed to use, especially with installing clamp, even not applied load, the needle will be leaned. It is because of the deadweight of the machine and clamp. Turn around the adjustable circle of dial to have [0] aimed at needle, which can't affect veracity of testing result.

结构名称 Parts Appellation

TABLE OF CONTENTS

Technical Specifications.....2

Parts Appellation.....3

Dimensions.....4

Test Stands.....5

Preparation before test.....11

Test.....12

Change of knob and movement of needle.....12

Others.....13

Maintenance.....14

Package List.....14

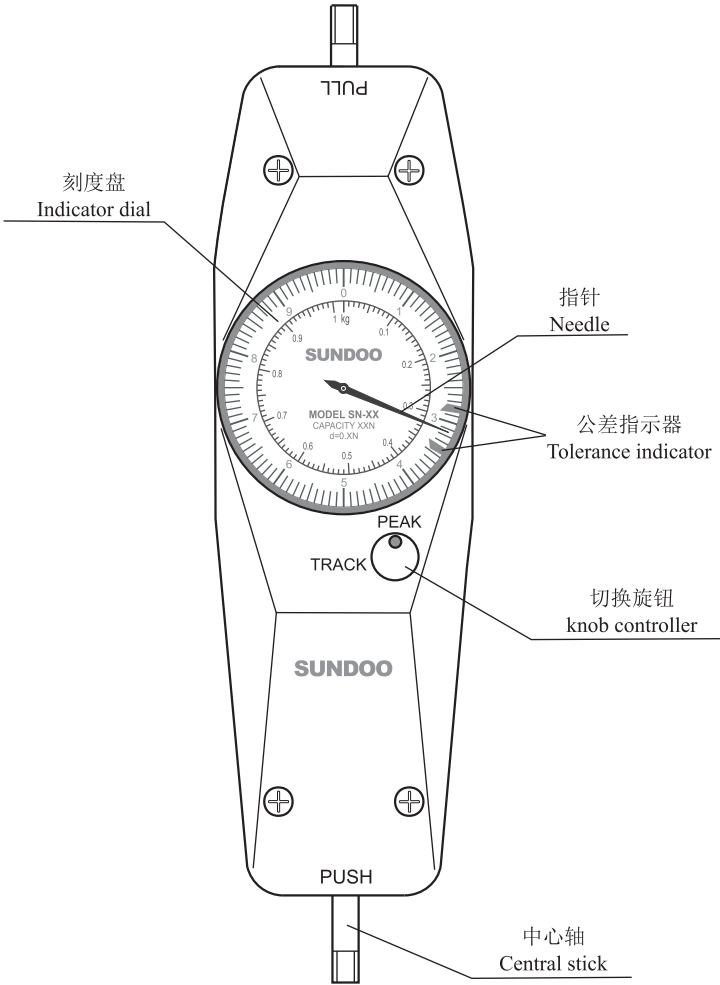

外形尺寸 Dimensions

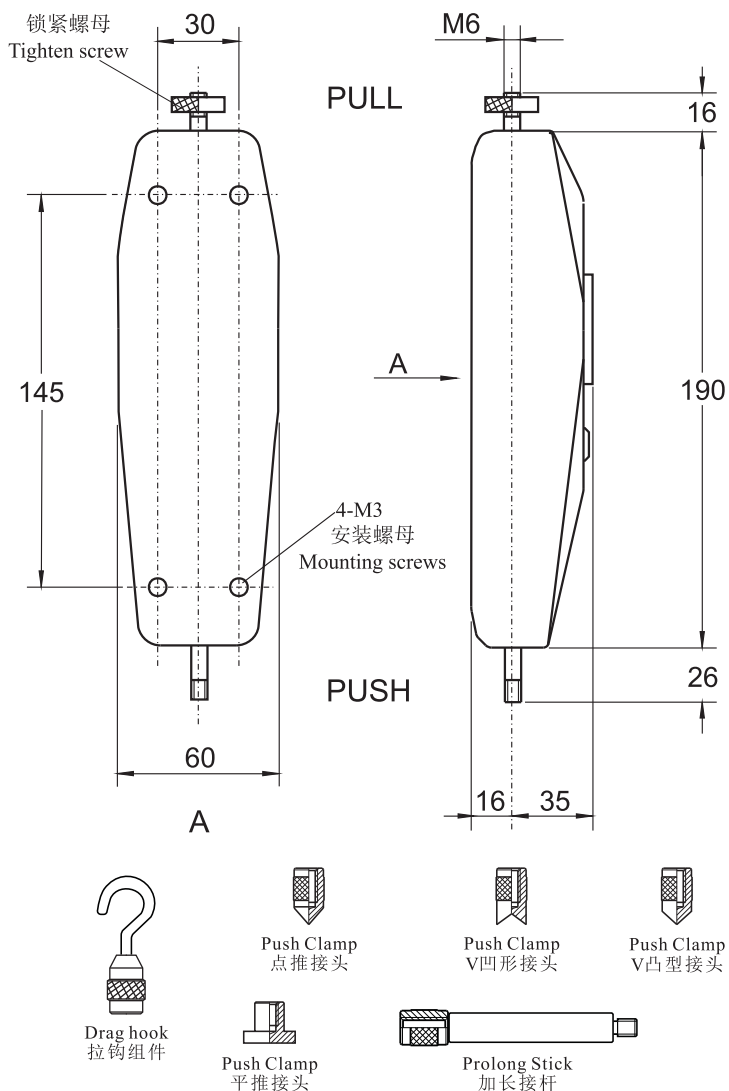

- 2、安装于其他试验机台上使用时，请使用所附4个M3螺钉来固定安装推拉力计，安装尺寸（见第4页）；
- 3、请勿超负荷使用仪器，以免造成仪器破损及故障；
- 4、请勿将推拉力计于低温、低湿或高温、高湿的场所存放或使用；
- 5、请将推拉力计存放于水平场所，以免出现推拉力计应跌落而导致损坏的事故；
- 6、发生故障请与原购买处或本公司联系；
- 7、本产品自销售之日起一个月内，在正常使用及外观无破损情况下出现产品质量问题，客户凭销售发票原件、有效保修卡及完整包装到原购买处或本公司更换相同规格型号的产品，更换以后的产品延续原产品的保修期限和条款；
- 8、本产品自销售之日起一年内，在正常使用情况下，出现非人为故障属保修范围（用户自行拆机或在其他维修点维修本公司不与保修），客户凭销售发票原件和有效保修卡联系原购买处，可获本公司免费保修一年；
- 9、本产品的保修条款仅适用于在中国市场上销售的SN系列产品，对超过包换期及保修期限的产品，客户可向原购买处查询维修事宜或与本公司联系，由本公司提供有偿维修。

包装清单

编号	名称	数量
1	机身	1
2	推头	4
3	拉钩	1
4	加长接杆	1
5	M3x14螺钉	4+1
6	使用说明书	1
7	产品出厂检验证书	1
8	合格证、保修卡	1

3、复数峰值的荷重值测试—1

最初有一个小的峰值，而接着还有一个大的峰值的测试时，将切换的旋钮置于荷重峰值[PEAK]位置，开始做测试，当荷重升高至一定值时不再变化时，此时荷重值为第一个小的峰值，直至测试结束，测得的峰值为第二个大的峰值。

4、复数峰值的荷重值测试—2

最初有一个大荷重值的峰值，可做如下两个步骤测试：

① 切换旋钮一直置于荷重峰值[PEAK]位置时，测试时只能测得最初峰值的荷重值。

② 切换旋钮先置于连续荷重[TRACK]，待至荷重第二次升高时将切换旋钮置于荷重峰值[PEAK]，可测得其次小的荷重峰值。

5、被测试物的荷重值的峰值为单数或者复数不清楚时的测试。

① 使用（1）的测试方法来确认荷重值的变化；

② 在①的荷重值变化确认后，再确认（2）、（3）、（4）中哪一个测试方法较适合被测试物，选择后再做测试。

其他

为了使推拉力计能得到正确及稳定的测试值，请务必充分利用附属的夹头工具。贵公司若要制造适合测试用的夹具时，请参考右图所示的中心棒连接尺寸。

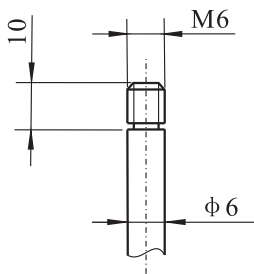

保养和维修

- 1、为配合待测产品所制作的夹具必须能够承受推拉力计的最大测试荷重，承受荷重能力不够时，会造成仪器破损或危及测试人员安全；

测试机台 Test Stands



SPJ 型



SLJ 型

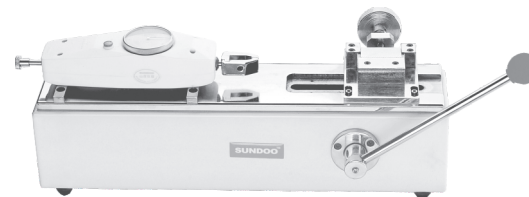

SPH 型



SJX-500H

注：以上测试机台为可选件，需另购
Note: Applied with (purchase additionally) test stand

测试前准备

选择合适的测试用接头夹具，安装到推拉力计上。

1、拉伸测试

将附属的拉力用夹具安装到标示拉[PULL]端的中心轴上。

2、压缩测试

从附属的推力夹具中，选择合适的测试用夹具，安装到标示[PUSH]端的中心轴上。

3、加长接杆的利用

无法接触到被测试物时，利用附属的加长接杆来安装夹具。

注意：使用加长接杆测试时，被测物与推拉力计需在同一直线上，假如不在一直线上时，将无法测得正确的荷重值。

4、切换旋钮的确认及操作方法

①荷重峰值[PEAK]——连续荷重[TRACK]的切换将切换旋钮轻轻的往下压后同时往左方向回转，使旋钮的“·”标记在连续荷重[TRACK]位置上。

②连续荷重[TRACK]——荷重峰值[PEAK]的切换将切换旋钮往右方向回转，此时旋钮弹出，旋钮的“·”标记在荷重峰值[PEAK]位置上。

③测试后的注意事项——测试完成后切换旋钮的“·”标记，请置于荷重峰值[PEAK]的位置。如果切换旋钮长期置于连续荷重[TRACK]位置的话，则内部的置零弹簧片使用寿命将会变短。

5、刻度盘调整

①请确认指针是否对准刻度盘的[0]。如果没有对准，请旋转刻度调整圈，刻度盘会一起动作，使指针对准[0]位。

②本仪器垂直放置使用时，特别在安装有夹具的情况下，即使没有施加负载，指针也会偏离[0]位，这是因为本仪器及夹具的自重原因。此时应旋转刻度调整圈使刻度盘的[0]与指针对准后，在进行测试。

6、公差指示带设定

转动公差指示器上的两个指针来设定测试所需的公差上下限。在测试时，当推拉力计指针指在公差指示器的指示范围内时，表示测试值为设定合格值；当推拉力计指针指在公差指示器的范围之外时，表示测试值为设定不合格值。

注意：如经常对本仪器施加超过最大测试荷重范围的负载时，荷重检出机构的弹性力将会逐渐劣化，导致无法检出正确的荷重值。使用时请注意不要施加超过最大荷重范围的负载，以维护本仪器的使用寿命。

测试

请用双手牢固地握住推拉力计或将推拉力计安装于合适的机台做测试。测试时请将被测试物和推拉力计置成一直线再执行测试，被测试物和推拉力计若没有成一直线，则测试时将无法得到正确的荷重值。

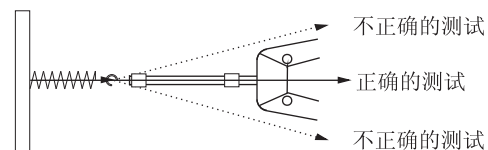

切换旋钮的活用和指针的动作

1、测试中荷重的变化

切换旋钮置于连续荷重[TRACK]时，指针会随着荷重值而变化。

2、单一峰值的荷重值测试

切换旋钮置于荷重峰值[PEAK]时，当测试达最大荷重值时，指针会停在最大荷重值的位置。要将指针归零，按下切换旋钮，指针将回到[0]的位置。